

L O G I C *w o r k*  
C A S E G O O D S  
LIST PRICES EFFECTIVE  
J U L Y 1 , 2 0 1 0

L O G I C W O R K



2 0 1 0

# HBF 2010 Price List Contents

Effective Date: July 1, 2010

**Mailing Address:**  
**HBF/HBF Textiles**  
PO Box 8  
Hickory, NC 28603-0008

**Shipping Address:**  
**HBF/HBF Textiles**  
900-12th Street Drive NW  
Hickory, NC 28601-4763

**Phone:** 828.328.2064  
**Fax:** 828.328.8816  
**info:** info@hbf.com  
www.hbf.com  
www.hbftextiles.com

## CONTENTS

	PAGE
<b>SPECIFICATIONS: LOGICwork</b>	
Access Panels, Removable.....	3
Doors.....	3
Drawers .....	3
Edge Details.....	3
Finish Availability Chart .....	2
FSC Certification.....	2
Garage Structure .....	6
Garage Worksurfaces.....	8
Grommets.....	4
Hardware .....	3
Levelers.....	3
Locks .....	4
Melamine.....	3
Modesty Panels .....	3
Pedestals.....	3
Specification Process .....	5
Suspension .....	3
Veneer Options.....	2
Worksurfaces.....	3
<b>COMPONENTS</b>	
Accessories	
Accessory Trays .....	41
Monitor Arm .....	41
Paper Tray .....	41
Power/Data Unit.....	41
Bookcases.....	31
Bridges.....	12
Cladding-Garage, Credenza, Return .....	16
Credenzas, Freestanding.....	36
Desk Extensions.....	10
Desks, Freestanding .....	32
File Pedestal, Mobile.....	12
Garage Components .....	15
Garage Structure .....	6
Garage Worksurfaces.....	8
Overhead Cabinets .....	17
Pantry Unit.....	27, 30
Reception Desk Returns .....	39
Reception Desks .....	38
Return Removable Access Panel .....	14
Returns .....	13
Table Desks.....	34
Vertical Storage, Double High .....	28
Vertical Storage, Single High .....	25
Wardrobe Unit.....	26, 27, 29

# HBF LOGICwork Casegood Specifications

All HBF casegood orders must be accompanied by suite layout drawings.

Drawings are needed to confirm proper unit configuration.

If drawings are not included, orders may be delayed to confirm specifications.

## Veneer

The following slip matched, plain sliced veneers are available with the finish options as shown below. Pricing for these veneers are shown by veneer grade.

HBF provides a number of light finishes that will not hide or mask the natural characteristics of wood. Due to the natural discoloration of wood substance and color variations in glued up stock, the finish may vary from piece to piece when selecting these finishes. These characteristics are not considered defects and merchandise will not be replaced.

Anigre: Color and grain variations are typical characteristics of anigre veneer. Color may range from light yellow to pale brown, sometimes with a pink tint. The grain pattern of anigre will also vary in frequency and size; grain pattern changes should be expected within a given product or suite of furniture.

## FSC Certification

HBF has been granted Forest Stewardship Council (FSC) Chain-of-Custody Certification (SW-COC-003305) by the SmartWood program of the Rainforest Alliance. This new certification agreement will allow HBF to offer FSC certified wood veneer or core on a project basis to maintain Chain-of-Custody for the design firm and client. FSC Chain-of-Custody certification tracks certified wood from the forest to final production to ensure that responsible forestry practices were maintained at every level and to preserve this natural resource for generations to come. Contact HBF Customer Relations for pricing and lead time information.

## Finish Availability Chart

	Cherry	Veneer Grade 1			Veneer Grade 2		Veneer Grade 3
		Maple	Ligno-Grain	Walnut	Rift Oak	Sapele	Anigre
01 Centennial	•		•				
02 Espresso	•		•				
03 Imperial	•		•				
05 Tuscan	•		•				
06 Amber	•		•			•	
07 Chestnut	•		•				
09 Onyx	•		•				
10 Honey	•		•				
11 Amazon	•		•				
12 Wheat		•	•				
16 Caramel		◆	•		•		
17 Scone						•	
18 Biscotti		M*					
19 Butterscotch							•
20 Hazelnut		M*					
21 Chai							•
22 Cider		M*					
23 Mocha					•		
24 Chocolat		M*					
25 Cocoa				•			
26 Latte		M*					
27 Honeycomb				•			
28 Nectar		M*					
29 Nutmeg				•			
30 Toffee		M*					

◆ **16 Caramel:** HBF offers this light or natural finish on maple veneer and strives to select the clearest veneer possible when Caramel is specified. Light finishes will not hide or mask the natural characteristics of wood; these characteristics are not considered defects and merchandise will not be replaced. Due to extra processes involved, a 5% Net upcharge will apply for this finish on maple veneer.

**M\* (maple):** These finishes are available only on maple seating and occasional table products and allow the specifier to create a finish that is complementary to non-maple veneers available on conference and casegood products. These finishes are not available on conference or casegood products.

18 Biscotti on maple complements 17 Scone on sapele

26 Latte on maple complements 25 Cocoa on walnut

20 Hazelnut on maple complements 19 Butterscotch on anigre

28 Nectar on maple complements 27 Honeycomb on walnut

22 Cider on maple complements 21 Chai on anigre

30 Toffee on maple complements 29 Nutmeg on walnut

24 Chocolat on maple complements 23 Mocha on rift oak

All conference and casegood products are standard with a 30° sheen.

## Custom Finishes

An upcharge of **10% Net** per unit for conference and casegood products, with a minimum upcharge of **\$500 Net** per order will apply for any custom wood finish.

# HBF LOGICwork Casegood Specifications

---

## Profile Edge Details

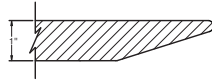

---

## Worksurfaces

LOGICwork components have a 1" (25mm) thick worksurface premium grade veneer top faces. Edges are bordered with solids or edgebands.

---

## Melamine

Melamine material is used on various LOGICwork components and is standard in two colors. Nubian Brown was selected to closely match the Satin Bronze metal finish, Fog Grey matches the Satin Pewter finish. The appropriate melamine color will be selected by HBF based on specification of finish for metal components.

---

## Pedestals

Two depths for desks and garages/credenzas/returns.

---

## Doors

Three (3) ply veneer doors are mounted with universal adjustment concealed hinges.

---

## Levelers

All floor casegoods have adjustable levelers.

---

## Modesty Panels

Desks modesty panels are available as finished, fixed panels that overlay the pedestal. Credenza, return back panels and bridge modesty panels are available as finished, fixed panels or as recessed, unfinished back removable access panels.

---

## Drawers in Wood Pedestals

Box and file drawers are 1/2" wood, doweled to form a four (4) sided rectangle with separate drawer front. Drawer bottoms are 1/4" thick and fitted in a dado groove so it is captured on four sides. Drawer faces are mechanically attached to allow for easy alignment. Each desk equipped with a box/box/file pedestal will include one maple divider and one maple pencil tray. Center drawers are optional and include a cherry or maple pencil and paper clip tray, see HBF Casegood Accessories. Center drawers are standard on all LOGICwork table desks.

---

## Suspension in Wood Pedestals

All box drawers are standard with telescopic, full extension, ball-bearing slides. All file drawers are standard with fully progressive, full extension, ball-bearing slides.

---

## Removable Access Panels

LOGICwork garages, credenzas, returns or bridges without a finished back can be specified with removable access panels in the kneespace. This panel is positioned 4-1/2" from the back of the unit and can be easily removed to allow for complete wall access. When installed, the top of the access panel will be 2 5/8" from the underside of the worksurface to allow for wire or cable egress. The back of this panel and the back of pedestals are unfinished.

LOGICwork credenzas, returns or bridges specified with a finished back will be constructed with a fully finished, fixed modesty panel.

---

## Pull Hardware Options

LOGICwork pulls are available in HBF Satin Nickel finish and are sized to fit appropriately on the door or drawer front.

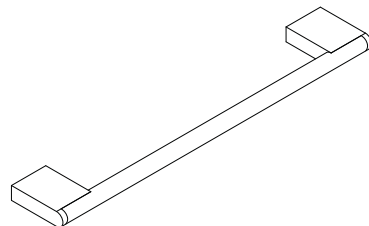

# HBF LOGICwork Casegood Specifications

## Locks

All wood case pedestals are standard with Satin Nickel face locks. All vertical storage cabinets, overhead cabinets and bookcases with doors are available with optional face locks. These locks will match the pedestal lock. **Add \$100 List** per lock for factory installation. (Locks standard on vertical cabinet file drawers)

Each individual unit (i.e. desk, credenza, overhead storage unit, etc.) will be keyed alike. If complete offices are required to be keyed alike, this designation must appear on each order. Units will be shipped with the lock barrels and locking mechanisms in place. A separate package will contain the appropriately numbered cylinders for field installations. If no specific lock instructions accompany the order, random keying between complete units will be installed.

## Grommets

Grommets are optional on all LOGICwork desks, credenzas, returns, bridges, table desks, and desk extensions. **Add \$195 List** for each factory installed grommet. Grommet is available in HBF Satin Pewter and Satin Bronze powder coat finish.

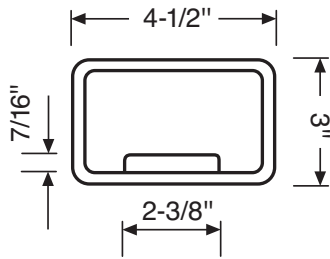

For added convenience, the drawings below should be used to define the placement of each optional grommet location. Please attach a copy to the order.

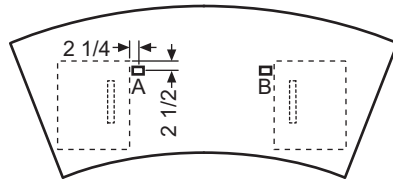

Desk - Arc Top

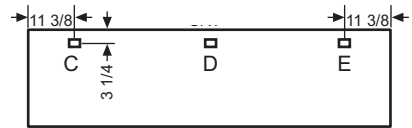

Credenza, Return, Bridge

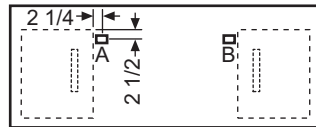

Desk - Rectangular Top

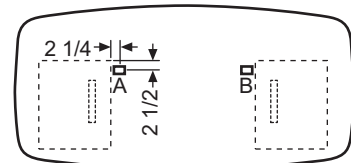

Desk - Arched Boat

If standard grommet placement locations do not provide suitable accessibility, a formal drawing of specified grommet location showing exact dimensions must accompany the order. No order specifying non-standard grommet placement will be entered until these drawings are received and approved by HBF.

# HBF LOGICwork

## Specification Process

---

LOGICwork components should be specified in the following order:

1. Garage Structure
2. Garage Worksurfaces
3. Desk Extensions, bridges and returns
4. Garage Components: Filing and storage, removable access panels, end supports, cladding, garage tackpanels
5. Overheads
6. Freestanding units: vertical storage units, bookcases, desks and credenzas
7. Accessories: paper management shelves and trays, power units and task lighting

The following price list pages provide ordering information and pricing for all LOGICwork components.

---

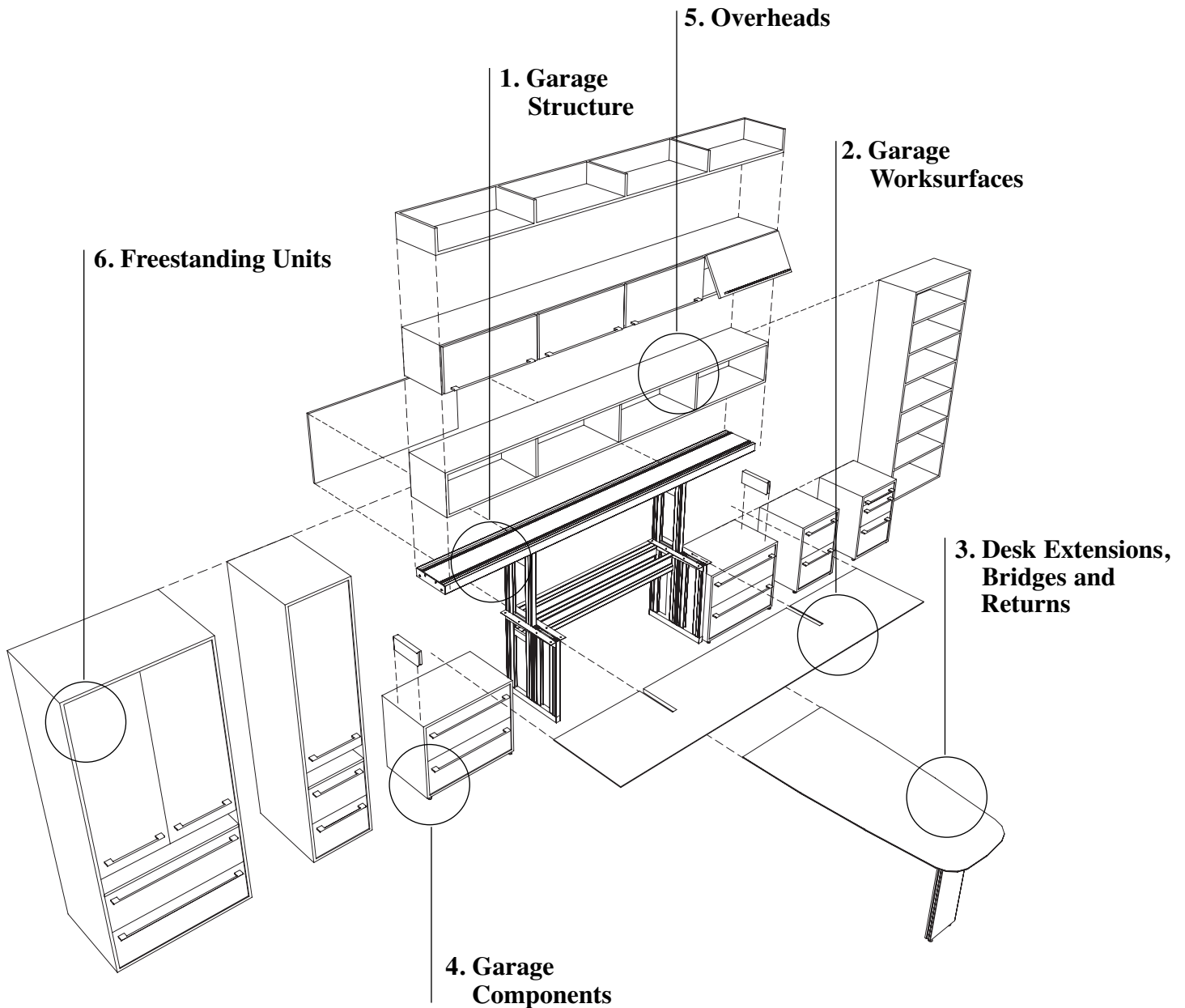

# HBF LOGICwork

## Garage Structure

The LOGICwork garage supports other LOGICwork components to create a variety of workwall configurations.

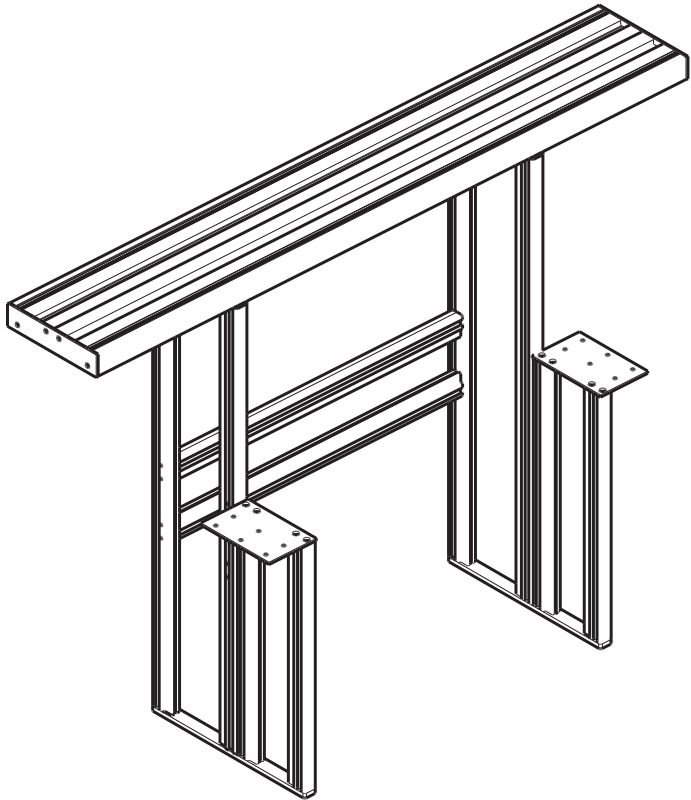

- Eight actual widths: 75", 81", 87", 93", 99", 105", 111", 117"
- Four overhang width dimensions: 0" (no overhang), 18", 30", 36"
- Maximum allowable distance or span between the two vertical supports is 84", minimum is 36"
- Each vertical support column is 1 1/2" wide, actual width of garage will be 3" wider than nominal width. Nominal width is used for garage specification purposes.
- The back of garages and all of its components are unfinished.
- Task lights may only be installed between the two vertical supports of the Garage Structure; refer to minimum opening under Task Lights to determine the style that can be accommodated between the vertical supports.

Diagrams below illustrate four overhang options for LOGICwork garages. Garage structures can be created in 87 different configurations by specifying different overall garage widths and different overhang widths. Included with diagrams are the appropriate style numbers for the examples. All configurations have an actual width of 87" and a nominal width of 84".

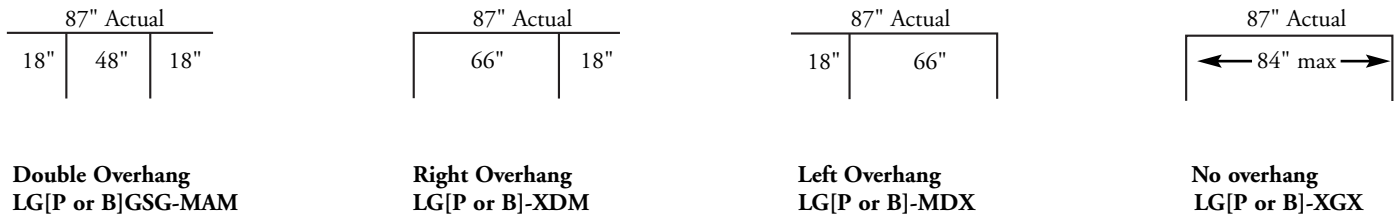

# HBF LOGICwork

## Garage Structure

**L G P G S G - M A M**

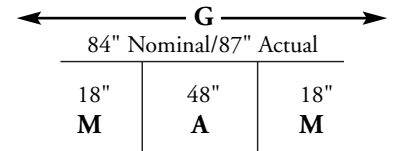
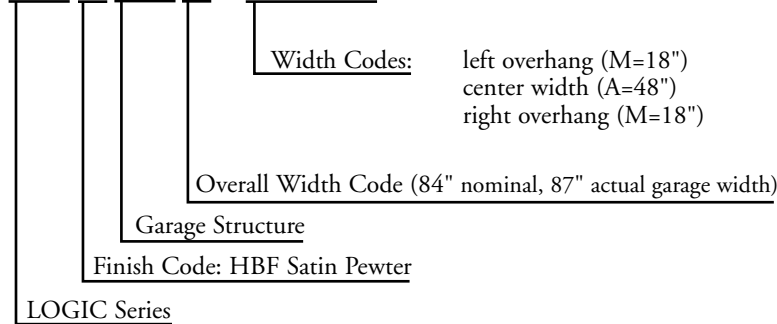

**Finish Codes:**  
 P = Satin Pewter  
 B = Satin Bronze

**Width Codes:**

Overall	Width
E	72" Nominal/75" Actual
F	78" Nominal/81" Actual
G	84" Nominal/87" Actual
H	90" Nominal/93" Actual
J	96" Nominal/99" Actual
K	102" Nominal/105" Actual
L	108" Nominal/111" Actual
T	114" Nominal/117" Actual

**Width Codes:**

Overhangs, Center Width	Width
X	0"
M	18"
P	30"
R	36"
S	42"
A	48"
B	54"
C	60"
D	66"
E	72"
F	78"
G	84"

Style Number	List Price	Nominal Width	OD	Weight
LG[P or B]GSE-[www]	1150	75	25	73
LG[P or B]GSF-[www]	1185	78	25	76
LG[P or B]GSG-[www]	1220	84	25	82
LG[P or B]GSH-[www]	1255	90	25	87
LG[P or B]GSJ-[www]	1290	96	25	93
LG[P or B]GSK-[www]	1325	102	25	99
LG[P or B]GSL-[www]	1385	108	25	104
LG[P or B]GST-[www]	1465	114	25	110

[P or B]: indicate finish for metal support, P = Satin Pewter, B= Satin Bronze  
 [www]: indicate three width codes for left overhang, center width, and right overhang

# HBF LOGICwork

## Garage Worksurfaces

---

LOGICwork garage worksurfaces are attached to the garage structure and include two recesses/slots to accommodate the garage vertical supports.

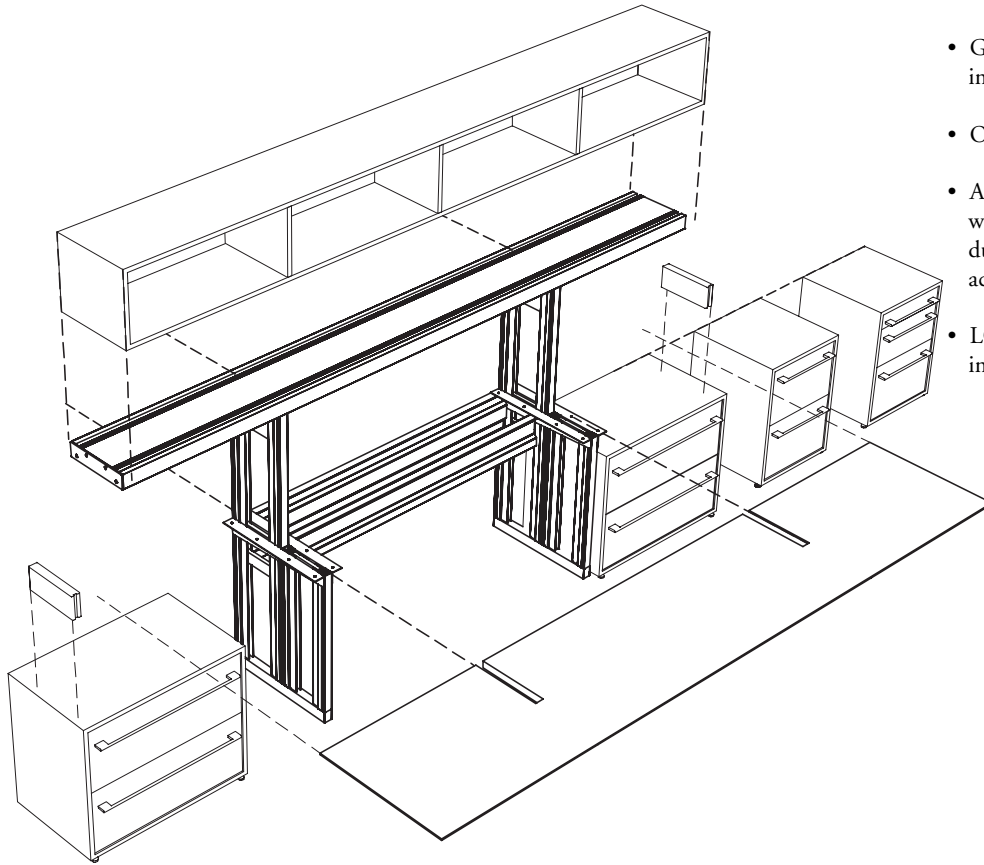

- Garage worksurfaces are available in 12 widths
- Overall depth is 25"
- Actual width of the garage worksurface will be 3" wider than nominal width due to the two 1 1/2" recesses that accommodate the garage vertical supports
- LOGICwork garage worksurfaces will include the appropriate standoffs.

# HBF LOGICwork

## Garage Worksurfaces

**L G 3 5 G - M A M**

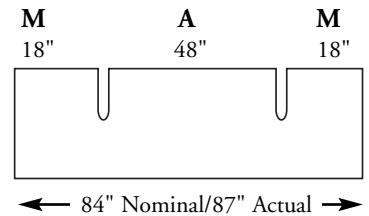
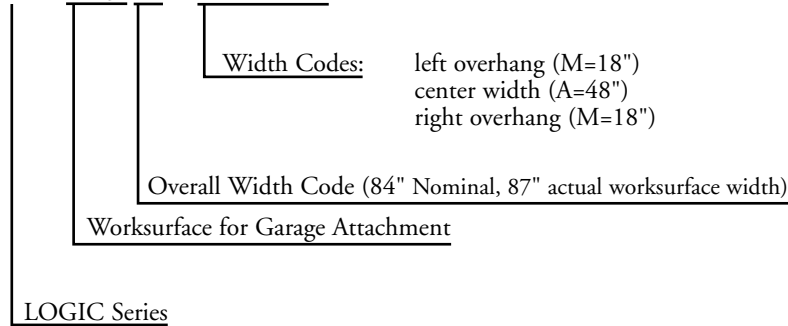

**Veneer:** Veneer species must be noted on each line item.

**Width Codes:**

Overall	Width
E	72" Nominal/75" Actual
F	78" Nominal/81" Actual
G	84" Nominal/87" Actual
H	90" Nominal/93" Actual
J	96" Nominal/99" Actual
K	102" Nominal/105" Actual
L	108" Nominal/111" Actual
T	114" Nominal/117" Actual
U	120" Nominal/123" Actual
V	126" Nominal/129" Actual
W	132" Nominal/135" Actual
X	138" Nominal/141" Actual

**Width Codes:**

Overhangs, Center Width	Width
X	0"
M	18"
P	30"
R	36"
S	42"
A	48"
B	54"
C	60"
D	66"
E	72"
F	78"
G	84"

Style Number	List Price			Nominal Width	OD	Weight
	Veneer 1	Veneer 2	Veneer 3			
LG35E-[www]	1125	1213	1344	72	25	70
LG35F-[www]	1280	1380	1529	78	25	75
LG35G-[www]	1330	1434	1589	84	25	80
LG35H-[www]	1380	1488	1649	90	25	85
LG35J-[www]	1430	1542	1709	96	25	90
LG35K-[www]	1485	1601	1774	102	25	96
LG35L-[www]	1505	1622	1798	108	25	102
LG35T-[www]	1605	1730	1918	114	25	108
LG35U-[www]	1625	1752	1942	120 (2 piece top)	25	116
LG35V-[www]	2395	2582	2862	126 (2 piece top)	25	126
LG35W-[www]	2445	2636	2922	132 (2 piece top)	25	136
LG35X-[www]	2500	2695	2987	138 (2 piece top)	25	146

Veneer species must be noted on each line item

[www]: indicate three width codes for left overhang, center width, and right overhang

# HBF LOGICwork

## Desk Extensions

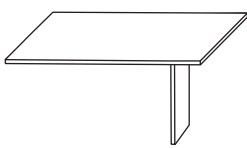
Style Number	List Price			Dimensions			Weight	
	Veneer 1	Veneer 2	Veneer 3	OW	OD	OH		
<b>Desk Extensions, Rectangular</b>								
	LG20A-[P or B]	2005	2161	2396	50 1/2	30	29	156
	LG20B-[P or B]	2110	2274	2521	50 1/2	36	29	175
	LG20C-[P or B]	2045	2205	2444	56 1/2	30	29	174
	LG20D-[P or B]	2160	2328	2581	56 1/2	36	29	196
	LG20E-[P or B]	2110	2274	2521	62 1/2	30	29	191
	LG20F-[P or B]	2210	2382	2641	62 1/2	36	29	226
	LG20G-[P or B]	2160	2328	2581	68 1/2	30	29	206
	LG20H-[P or B]	2265	2441	2706	68 1/2	36	29	254
	LG20J-[P or B]	2210	2382	2641	74 1/2	30	29	222
	LG20K-[P or B]	2315	2495	2766	74 1/2	36	29	281

Veneer species must be noted on each line item

[P or B]: indicate finish for metal support, P = Satin Pewter, B= Satin Bronze

### Desk Extensions, Arched Boat

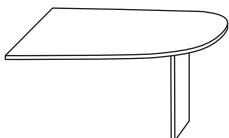
	LG25A-[P or B]	2415	2603	2886	50 1/2	30	29	156
	LG25B-[P or B]	2520	2716	3011	50 1/2	36	29	175
	LG25C-[P or B]	2455	2647	2934	56 1/2	30	29	174
	LG25D-[P or B]	2570	2770	3071	56 1/2	36	29	196
	LG25E-[P or B]	2520	2716	3011	62 1/2	30	29	191
	LG25F-[P or B]	2620	2824	3131	62 1/2	36	29	226
	LG25G-[P or B]	2570	2770	3071	68 1/2	30	29	206
	LG25H-[P or B]	2675	2883	3196	68 1/2	36	29	254
	LG25J-[P or B]	2620	2824	3131	74 1/2	30	29	222
	LG25K-[P or B]	2725	2937	3256	74 1/2	36	29	281

Veneer species must be noted on each line item

[P or B]: indicate finish for metal support, P = Satin Pewter, B= Satin Bronze

### Desk Extensions, Arc LH

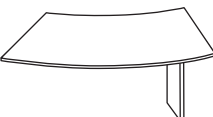
	LG26A-[P or B]	2365	2549	2826	48	30	29	156
	LG26B-[P or B]	2470	2662	2951	48	36	29	175
	LG26C-[P or B]	2405	2593	2874	54	30	29	174
	LG26D-[P or B]	2520	2716	3011	54	36	29	196
	LG26E-[P or B]	2470	2662	2951	60	30	29	191
	LG26F-[P or B]	2570	2770	3071	60	36	29	226
	LG26G-[P or B]	2520	2716	3011	66	30	29	206
	LG26H-[P or B]	2620	2824	3131	66	36	29	254
	LG26J-[P or B]	2570	2770	3071	72	30	29	222
	LG26K-[P or B]	2675	2883	3196	72	36	29	281

Veneer species must be noted on each line item

[P or B]: indicate finish for metal support, P = Satin Pewter, B= Satin Bronze

### Veneer species must be noted on each line item

Veneer Grade 1	Veneer Grade 2	Veneer Grade 3
Cherry	Rift Oak	Anigre
Maple	Sapele	
Ligno-Grain		
Walnut		

# HBF LOGICwork

## Desk Extensions

Style Number	List Price			Dimensions			Weight
	Veneer 1	Veneer 2	Veneer 3	OW	OD	OH	
<b>Desk Extensions, Arc RH</b>							
LG27A-[P or B]	2365	2549	2826	48	30	29	156
LG27B-[P or B]	2470	2662	2951	48	36	29	175
LG27C-[P or B]	2405	2593	2874	54	30	29	174
LG27D-[P or B]	2520	2716	3011	54	36	29	196
LG27E-[P or B]	2470	2662	2951	60	30	29	191
LG27F-[P or B]	2570	2770	3071	60	36	29	226
LG27G-[P or B]	2520	2716	3011	66	30	29	206
LG27H-[P or B]	2620	2824	3131	66	36	29	254
LG27J-[P or B]	2570	2770	3071	72	30	29	222
LG27K-[P or B]	2675	2883	3196	72	36	29	281



Veneer species must be noted on each line item  
 [P or B]: indicate finish for metal support, P = Satin Pewter, B= Satin Bronze

<b>Desk Extensions, Rectangular with Modesty</b>							
LG20A-[P or B]M	2520	2716	3011	50 1/2	30	29	156
LG20B-[P or B]M	2620	2824	3131	50 1/2	36	29	175
LG20C-[P or B]M	2560	2760	3059	56 1/2	30	29	174
LG20D-[P or B]M	2675	2883	3196	56 1/2	36	29	196
LG20E-[P or B]M	2620	2824	3131	62 1/2	30	29	191
LG20F-[P or B]M	2725	2937	3256	62 1/2	36	29	226
LG20G-[P or B]M	2675	2883	3196	68 1/2	30	29	206
LG20H-[P or B]M	2775	2991	3316	68 1/2	36	29	254
LG20J-[P or B]M	2725	2937	3256	74 1/2	30	29	222
LG20K-[P or B]M	2825	3045	3376	74 1/2	36	29	281

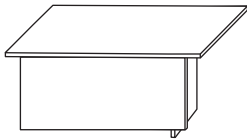

Veneer species must be noted on each line item  
 [P or B]: indicate finish for metal support, P = Satin Pewter, B= Satin Bronze

<b>Desk Extensions, Arched Boat with Modesty</b>							
LG25A-[P or B]M	2930	3158	3501	50 1/2	30	29	156
LG25B-[P or B]M	3030	3266	3621	50 1/2	36	29	175
LG25C-[P or B]M	2970	3202	3549	56 1/2	30	29	174
LG25D-[P or B]M	3085	3325	3686	56 1/2	36	29	196
LG25E-[P or B]M	3030	3266	3621	62 1/2	30	29	191
LG25F-[P or B]M	3135	3379	3746	62 1/2	36	29	226
LG25G-[P or B]M	3085	3325	3686	68 1/2	30	29	206
LG25H-[P or B]M	3185	3433	3806	68 1/2	36	29	254
LG25J-[P or B]M	3135	3379	3746	74 1/2	30	29	222
LG 25K-[P or B]M	3235	3487	3866	74 1/2	36	29	281

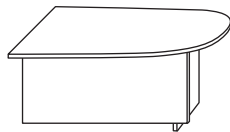

Veneer species must be noted on each line item  
 [P or B]: indicate finish for metal support, P = Satin Pewter, B= Satin Bronze

**Veneer species must be noted on each line item**

Veneer Grade 1	Veneer Grade 2	Veneer Grade 3
Cherry	Rift Oak	Anigre
Maple	Sapele	
Ligno-Grain		
Walnut		

# HBF LOGICwork Bridges

Style Number	List Price			Dimensions			
	Veneer 1	Veneer 2	Veneer 3	OW	OD	OH	Weight

## Mobile Pedestal

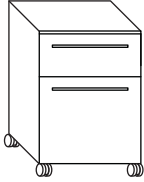

<b>LG30</b>	<b>1740</b>	<b>1876</b>	<b>2079</b>	18	21	25 1/2	135
-------------	-------------	-------------	-------------	----	----	--------	-----

Veneer species must be noted on each line item

Note: Casters, one box drawer and one file drawer with lock. Pedestal will nest under any 29" overhead worksurface.

## Bridges

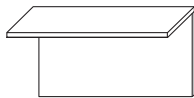

<b>LG52A</b>	<b>1300</b>	<b>1401</b>	<b>1553</b>	42	25	29	147
<b>LG52B</b>	<b>1350</b>	<b>1455</b>	<b>1613</b>	48	25	29	159
<b>LG52C</b>	<b>1710</b>	<b>1843</b>	<b>2043</b>	54	25	29	171

Veneer species must be noted on each line item

Finished, fixed modesty panel.

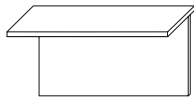

<b>LG51A</b>	<b>1100</b>	<b>1186</b>	<b>1314</b>	42	25	29	137
<b>LG51B</b>	<b>1140</b>	<b>1229</b>	<b>1362</b>	48	25	29	149
<b>LG51C</b>	<b>1415</b>	<b>1525</b>	<b>1691</b>	54	25	29	161

Veneer species must be noted on each line item

Removable access panel; wood front, standard black, unfinished back.

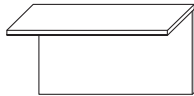

<b>LG51A-[P or B]</b>	<b>995</b>	<b>1073</b>	<b>1189</b>	42	25	29	137
<b>LG51B-[P or B]</b>	<b>1040</b>	<b>1121</b>	<b>1242</b>	48	25	29	149
<b>LG51C-[P or B]</b>	<b>1315</b>	<b>1417</b>	<b>1571</b>	54	25	29	161

Veneer species must be noted on each line item

[P or B]: indicate finish for melamine back, P = Satin Pewter, B= Satin Bronze

Removable access panel; melamine front, standard black, unfinished back.

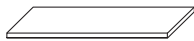

<b>LG50A</b>	<b>665</b>	<b>717</b>	<b>794</b>	42	25		104
<b>LG50B</b>	<b>1010</b>	<b>1089</b>	<b>1207</b>	48	25		116
<b>LG50C</b>	<b>980</b>	<b>1056</b>	<b>1171</b>	54	25		128

Veneer species must be noted on each line item

Bridge top only.



<b>LG35CT</b>	<b>510</b>	<b>550</b>	<b>609</b>	24 1/2	12 1/4		25
---------------	------------	------------	------------	--------	--------	--	----

Veneer species must be noted on each line item

Corner bridge top only, to be mounted between two rectangular worksurfaces connected at a 90 degree angle. Mounting hardware included. Front edge of corner top has the LOGICwork edge detail, flat on two back edges.

### Veneer species must be noted on each line item

<u>Veneer Grade 1</u>	<u>Veneer Grade 2</u>	<u>Veneer Grade 3</u>
Cherry	Rift Oak	Anigre
Maple	Sapele	
Ligno-Grain		
Walnut		

# HBF LOGICwork

## Returns

- LOGICwork returns attach to garage worksurfaces, freestanding credenzas or single pedestal desks
- Returns are specified by components; worksurface top, removable access panels, end panels and filing/storage units
- Tops are available in 22 different widths
- Pedestals are available in wood or metal with three different drawer front options

### Return Worksurface

Style Numbers:	Description
LG41 (w)	A return worksurface with an edge detail on the user side
LG42 (w)	A return worksurface with edge details on the user side and the unattached end
LG43 (w)	A return worksurface with edge details on the user and visitor sides and the unattached end, this top includes a fixed finished modesty panel

**Veneer:** Veneer species must be noted on each line item

Width Codes (w):	Nominal Width	OD	List Price Style Numbers 41, 42			List Price Style Number 43			Weight
			Veneer 1	Veneer 2	Veneer 3	Veneer 1	Veneer 2	Veneer 3	
M	18	25	405	437	484	1045	1126	1248	33
N	24	25	450	485	537	1095	1180	1393	37
P	30	25	560	604	669	1195	1288	1521	41
R	36	25	600	647	717	1250	1347	1590	45
S	42	25	665	717	794	1300	1401	1654	49
A	48	25	705	760	842	1350	1455	1718	53
B	54	25	980	1056	1171	1710	1843	2176	57
C	60	25	1020	1100	1219	1710	1843	2176	61
D	66	25	1075	1159	1284	1820	1962	2317	65
E	72	25	1125	1213	1344	1855	1999	2360	70
F	78	25	1280	1380	1529	2210	2382	2813	75
G	84	25	1330	1434	1589	2265	2441	2882	80
H	90	25	1380	1488	1649	2425	2614	3087	85
J	96	25	1430	1542	1709	2480	2673	3156	90
K	102	25	1485	1601	1774	2715	2927	3456	96
L	108	25	1505	1622	1798	2755	2970	3507	102
T	114	25	1605	1730	1918	2910	3137	3704	108
U	120	25	1625	1752	1942 (2 piece top)	2940	3169	3742 (2 piece top)	116
V	126	25	2395	2582	2862 (2 piece top)	3710	3999	4722 (2 piece top)	126
W	132	25	2445	2636	2922 (2 piece top)	3760	4053	4786 (2 piece top)	136
X	138	25	2500	2695	2987 (2 piece top)	3810	4107	4850 (2 piece top)	146

### Style Number Descriptions

**Product Code:** Denotes the product as a return and also specifies the number of return finished sides.

**41** - 1 Side: Front finished. Return back is unfinished.

**42** - 2 Sides: Front and one end finished. Return back is unfinished.

**43** - 3 Sides: Front, back and one end finished.



Finished - 1 Side (**41**)  
Nominal Width = Actual Width  
Actual Depth = 25"  
Standard Black Unfinished Back



Finished - 2 Sides (**42**)  
Nominal Width + 2 1/2" = Actual Width  
Actual Depth = 25"  
Standard Black Unfinished Back



Finished - 3 Sides (**43**)  
Nominal Width + 2 1/2" = Actual Width  
Actual Depth = 25"  
Finished Back

# HBF LOGICwork

## Returns, Removable Access Panels, End Panels

Style Number	Description	List Price			Dimensions				
		Veneer 1	Veneer 2	Veneer 3	OW	OD	OH	Weight	
<b>Return Pedestals, Wood Cases with Wood Drawer Face</b>									
LG30A	Box/Box/File	1525	1644	1822	18	20	25 1/2	125	
LG30B	File/File	1525	1644	1822	18	20	25 1/2	125	
LG30C	Lateral File	1835	1978	2193	30	20	25 1/2	140	
LG30D	Lateral File	1945	2097	2324	36	20	25 1/2	140	
LG30U	Single Door Cabinet	1245	1342	1487	18	20	25 1/2	95	
LG30E	Double Door Cabinet	1555	1676	1858	30	20	25 1/2	95	
LG30F	Double Door Cabinet	1585	1709	1894	36	20	25 1/2	105	

Veneer species must be noted on each line item

<b>Removable Access Panel with Wood Face</b>									
LG30G1	375	404	448	6"-30"	24				
LG30G2	440	474	525	31"-60"	42				
LG30G3	805	868	962	61"-90"	60				
LG30G4	990	1180	1308	91"-138"	60				

Veneer species must be noted on each line item

<b>Removable Access Panel with Melamine Face</b>									
LG[P or B]30G1	275	N/A	N/A	6"-30"	24				
LG[P or B]30G2	335	N/A	N/A	31"-60"	42				
LG[P or B]30G3	705	N/A	N/A	61"-90"	60				
LG[P or B]30G4	905	N/A	N/A	91"-138"	60				

[P or B]: indicate P for Satin Pewter, B for Satin Bronze

<b>End Panels</b>									
LG[P or B]30K (with veneer panel)	690	744	824	N/A	45				

[P or B]: indicate P for Satin Pewter, B for Satin Bronze

Veneer species must be noted on each line item

LG[P or B]30L	480	N/A	N/A	N/A	22				
---------------	-----	-----	-----	-----	----	--	--	--	--

[P or B]: indicate P for Satin Pewter, B for Satin Bronze

Veneer species must be noted on each line item

Veneer Grade 1	Veneer Grade 2	Veneer Grade 3
Cherry	Rift Oak	Anigre
Maple	Sapele	
Ligno-Grain		
Walnut		

# HBF LOGICwork

## Garage Components

### Filing and Storage Units

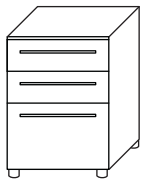

**Box/Box/File**  
18" OW

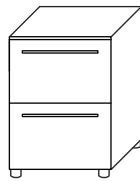

**File/File**  
18" OW

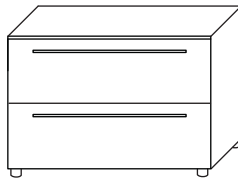

**Lateral File**  
30" and 36" OW

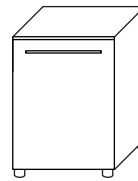

**Single Door Cabinet**  
18" OW

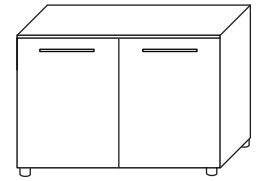

**Double Door Cabinet**  
30" and 36" OH

- Specify metal foot color

Style Number	Description	List Price			Dimensions				
		Veneer 1	Veneer 2	Veneer 3	OW	OD	OH	Weight	
<b>Garage Pedestals, Wood Cases with Wood Drawer Fronts</b>									
LG 30A	Box/Box/File	1525	1644	1822	18	20	25 1/2	125	
LG 30B	File/File	1525	1644	1822	18	20	25 1/2	125	
LG 30C	Lateral File	1835	1978	2193	30	20	25 1/2	140	
LG 30D	Lateral File	1945	2097	2324	36	20	25 1/2	140	
LG 30UL	Single Door Cabinet, Hinged Left	1245	1342	1487	18	20	25 1/2	95	
LG 30UR	Single Door Cabinet, Hinged Right	1245	1342	1487	18	20	25 1/2	95	
LG 30E	Double Door Cabinet	1555	1676	1858	30	20	25 1/2	105	
LG 30F	Double Door Cabinet	1585	1709	1894	36	20	25 1/2	110	

Veneer species must be noted on each line item

#### Removable Access Panel with Wood Face

LG30G1	375	404	448	6"-30"	24
LG30G2	440	474	525	31"-60"	42
LG30G3	805	868	962	61"-90"	60

Veneer species must be noted on each line item

#### Removable Access Panel with Melamine Face

LG[P or B]30G1	275	N/A	N/A	6"-30"	24
LG[P or B]30G2	335	N/A	N/A	31"-60"	42
LG[P or B]30G3	705	N/A	N/A	61"-90"	60

[P or B]: indicate P for Satin Pewter Melamine, B for Satin Bronze Melamine

#### End Panels with Veneer Panel

LG[P or B]30K	690	744	824	N/A	45
---------------	-----	-----	-----	-----	----

[P or B]: indicate P for Satin Pewter, B for Satin Bronze

Veneer species must be noted on each line item

LG[P or B]30L	480	N/A	N/A	N/A	22
---------------	-----	-----	-----	-----	----

[P or B]: indicate P for Satin Pewter, B for Satin Bronze

Garage Tackpanels	Fabric	List Price			Dimensions	
		Veneer 1	Veneer 2	Veneer 3	OW	OH
LG30T1	3 yards	315	N/A	N/A	18"-30" Nominal Width	15
LG30T2	3 yards	430	N/A	N/A	31"-60" Nominal Width	25
LG30T3	3 yards	510	N/A	N/A	61"-84" Nominal Width	35

Veneer species must be noted on each line item

Veneer Grade 1	Veneer Grade 2	Veneer Grade 3
Cherry	Rift Oak	Anigre
Maple	Sapele	
Ligno-Grain		
Walnut		

# HBF LOGICwork

## Garage, Credenza, Return, or Desk Cladding

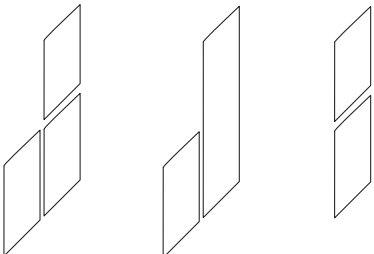
	Style Number	Description	List Price		
			Veneer 1	Veneer 2	Veneer 3
<b>Garage Vertical Support Cladding, Metal</b>					
	LG[P or B]GC-FC	Full Center	150	N/A	N/A
	LG[P or B]GC-FE	Full End	150	N/A	N/A
	LG[P or B]GC-HC	Half Center	100	N/A	N/A

Full Center      Full End      Half Center

[P or B]: indicate P for Satin Pewter, B for Satin Bronze

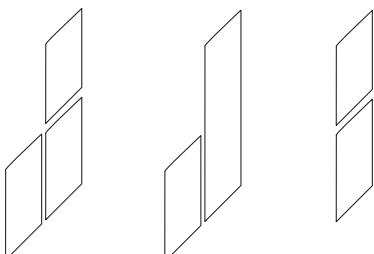
<b>Garage Vertical Support Cladding, Wood</b>					
	LG[P or B]GC-FC-V	Full Center	405	437	484
	LG[P or B]GC-FE-V	Full End	405	437	484
	LG[P or B]GC-HC-V	Half Center	265	285	316

Full Center      Full End      Half Center

Veneer species must be noted on each line item

[P or B]: indicate P for Satin Pewter, B for Satin Bronze

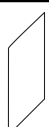
<b>Garage, Credenza, or Return Recessed End Cladding, Metal</b>					
	LG[P or B]REC		100	N/A	N/A

[P or B]: indicate P for Satin Pewter, B for Satin Bronze

<b>Garage, Credenza, or Return Recessed End Cladding, Wood</b>					
	LG[P or B]REC-V		265	285	316

Veneer species must be noted on each line item

[P or B]: indicate P for Satin Pewter, B for Satin Bronze

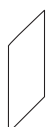
<b>Desk Recessed End Cladding, Metal</b>					
	LG[P or B]RDC		100	N/A	N/A

[P or B]: indicate P for Satin Pewter, B for Satin Bronze

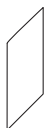
<b>Desk Recessed End Cladding, Wood</b>					
	LG[P or B]RDC-V		265	285	316



Veneer species must be noted on each line item

[P or B]: indicate P for Satin Pewter, B for Satin Bronze

**Veneer species must be noted on each line item**

Veneer Grade 1	Veneer Grade 2	Veneer Grade 3
Cherry	Rift Oak	Anigre
Maple	Sapele	
Ligno-Grain		
Walnut		

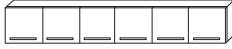

# HBF LOGICwork Overhead Cabinets

Style Number	Fabric	List Price			Number of Doors	Dimensions			Weight
		Veneer 1	Veneer 2	Veneer 3		OW	OD	OH	
<b>Overhead Cabinets, Garage Mount with Hinged Wood Doors and Melamine Back</b>									
	LG64M-A[P or B]	2365	2549	2826	4	75	14 5/8	14 1/2	195
	LG64N-A[P or B]	2900	3126	3465	6	81	14 5/8	14 1/2	215
	LG64P-A[P or B]	3095	3336	3698	6	87	14 5/8	14 1/2	215
	LG64R-A[P or B]	3275	3531	3914	6	93	14 5/8	14 1/2	225
	LG64S-A[P or B]	3480	3752	4159	6	99	14 5/8	14 1/2	225
	LG64T-A[P or B]	3565	3843	4260	6	105	14 5/8	14 1/2	235
	LG64U-A[P or B]	3860	4161	4613	8(2 piece unit)	111	14 5/8	14 1/2	235
	LG64V-A[P or B]	4025	4339	4810	8(2 piece unit)	117	14 5/8	14 1/2	245

Veneer species must be noted on each line item

[P or B]: indicate P for Satin Pewter/Fog Grey, B for Satin Bronze/Nubian Brown

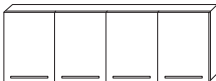
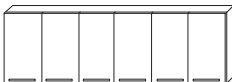

## Overhead Cabinets, Garage Mount with Hinged Wood Doors and Melamine Back (Double High)

	LG64M-A[P or B]2	3470	3741	4147	4	75	14 5/8	28 1/4	220
	LG64N-A[P or B]2	4035	4350	4822	6	81	14 5/8	28 1/4	240
	LG64P-A[P or B]2	4250	4582	5079	6	87	14 5/8	28 1/4	240
	LG64R-A[P or B]2	4445	4792	5312	6	93	14 5/8	28 1/4	250
	LG64S-A[P or B]2	4650	5013	5557	6	99	14 5/8	28 1/4	250
	LG64T-A[P or B]2	4855	5234	5802	6	105	14 5/8	28 1/4	260
	LG64U-A[P or B]2	5060	5455	6047	8(2 piece unit)	111	14 5/8	28 1/4	260
	LG64V-A[P or B]2	5265	5676	6292	8(2 piece unit)	117	14 5/8	28 1/4	270

Veneer species must be noted on each line item

[P or B]: indicate P for Satin Pewter/Fog Grey, B for Satin Bronze/Nubian Brown

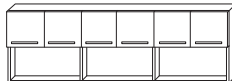
## Overhead Cabinets, Garage Mount with Half High Hinged Wood Doors and Wood Back (Double High)

	LG64M-C2	3370	3633	4027	4	75	14 5/8	28 1/4	215
	LG64N-C2	3935	4242	4702	6	81	14 5/8	28 1/4	235
	LG64P-C2	4150	4474	4959	6	87	14 5/8	28 1/4	235
	LG64R-C2	4345	4684	5192	6	93	14 5/8	28 1/4	245
	LG64S-C2	4550	4905	5437	6	99	14 5/8	28 1/4	245
	LG64T-C2	4755	5126	5682	6	105	14 5/8	28 1/4	255
	LG64U-C2	4960	5347	5927	8(2 piece unit)	111	14 5/8	28 1/4	255
	LG64V-C2	5165	5568	6172	8(2 piece unit)	117	14 5/8	28 1/4	265

Veneer species must be noted on each line item

Due to the depth of door hardware, end doors on LOGICwork overhead units are hinged to open inward in order to prevent damage to adjacent vertical storage units or wall.

Veneer species must be noted on each line item

Veneer Grade 1	Veneer Grade 2	Veneer Grade 3
Cherry	Rift Oak	Anigre
Maple	Sapele	
Ligno-Grain		
Walnut		

# HBF LOGICwork Overhead Cabinets

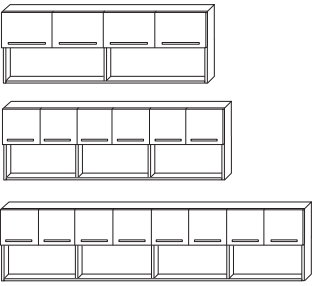
Style Number	Fabric	List Price			Number of Doors	Dimensions			Weight	
		Veneer 1	Veneer 2	Veneer 3		OW	OD	OH		
<b>Overhead Cabinets, Garage Mount with Half High Hinged Wood Doors and Melamine Back (Double High)</b>										
	LG64M-C[P or B]2		3115	3358	3722	4	75	14 5/8	28 1/4	215
	LG64N-C[P or B]2		3635	3962	4392	6	81	14 5/8	28 1/4	235
	LG64P-C[P or B]2		3890	4194	4649	6	87	14 5/8	28 1/4	235
	LG64R-C[P or B]2		4085	4404	4882	6	93	14 5/8	28 1/4	245
	LG64S-C[P or B]2		4290	4625	5127	6	99	14 5/8	28 1/4	245
	LG64T-C[P or B]2		4495	4846	5372	6	105	14 5/8	28 1/4	255
	LG64U-C[P or B]2		4700	5067	5617	8 (2 piece unit)	111	14 5/8	28 1/4	255
	LG64V-C[P or B]2		4905	5288	5862	8 (2 piece unit)	117	14 5/8	28 1/4	265
Veneer species must be noted on each line item [P or B]: indicate P for Satin Pewter/Fog Grey, B for Satin Bronze/Nubian Brown										

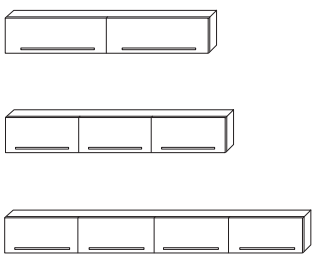
<b>Overhead Cabinets, Garage Mount with Wood Flipper Doors and Melamine Back</b>										
	LG64M-B[P or B]		2365	2549	2826	2	75	14 5/8	14 1/2	195
	LG64N-B[P or B]		2900	3126	3465	3	81	14 5/8	14 1/2	215
	LG64P-B[P or B]		3095	3336	3698	3	87	14 5/8	14 1/2	215
	LG64R-B[P or B]		3275	3531	3914	3	93	14 5/8	14 1/2	225
	LG64S-B[P or B]		3480	3752	4159	3	99	14 5/8	14 1/2	225
	LG64T-B[P or B]		3565	3843	4260	3	105	14 5/8	14 1/2	235
	LG64U-B[P or B]		3860	4161	4613	4 (2 piece unit)	111	14 5/8	14 1/2	235
	LG64V-B[P or B]		4025	4339	4810	4 (2 piece unit)	117	14 5/8	14 1/2	245
Veneer species must be noted on each line item [P or B]: indicate P for Satin Pewter/Fog Grey, B for Satin Bronze/Nubian Brown										

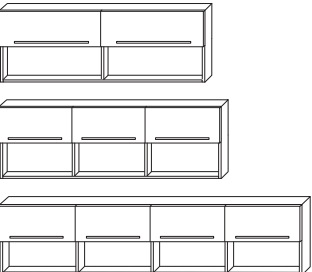
<b>Overhead Cabinets, Garage Mount with Half High Wood Flipper Doors and Wood Back (Double High)</b>										
	LG64M-D2		3370	3633	4027	2	75	14 5/8	28 1/4	215
	LG64N-D2		3935	4242	4702	3	81	14 5/8	28 1/4	235
	LG64P-D2		4150	4474	4959	3	87	14 5/8	28 1/4	235
	LG64R-D2		4345	4684	5192	3	93	14 5/8	28 1/4	245
	LG64S-D2		4550	4905	5437	3	99	14 5/8	28 1/4	245
	LG64T-D2		4755	5126	5682	3	105	14 5/8	28 1/4	255
	LG64U-D2		4960	5347	5927	4 (2 piece unit)	111	14 5/8	28 1/4	255
	LG64V-D2		5165	5568	6172	4 (2 piece unit)	117	14 5/8	28 1/4	265
Veneer species must be noted on each line item										

Due to the depth of door hardware, end doors on LOGICwork overhead units are hinged to open inward in order to prevent damage to adjacent vertical storage units or wall.



**Veneer species must be noted on each line item**

Veneer Grade 1	Veneer Grade 2	Veneer Grade 3
Cherry	Rift Oak	Anigre
Maple	Sapele	
Ligno-Grain		
Walnut		

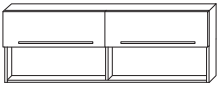
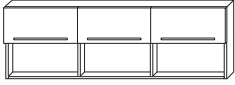
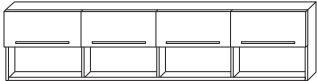
# HBF LOGICwork Overhead Cabinets

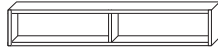
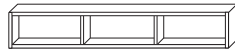
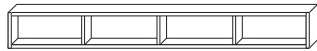
Style Number	Fabric	List Price			Number of Doors	Dimensions			Weight
		Veneer 1	Veneer 2	Veneer 3		OW	OD	OH	
<b>Overhead Cabinets, Garage Mount with Half High Wood Flipper Doors and Melamine Back (Double High)</b>									
	LG64M-D[P or B]2	3115	3358	3722	2	75	14 5/8	28 1/4	215
	LG64N-D[P or B]2	3675	3962	4392	3	81	14 5/8	28 1/4	235
	LG64P-D[P or B]2	3890	4194	4649	3	87	14 5/8	28 1/4	235
	LG64R-D[P or B]2	4085	4404	4882	3	93	14 5/8	28 1/4	245
	LG64S-D[P or B]2	4290	4625	5127	3	99	14 5/8	28 1/4	245
	LG64T-D[P or B]2	4495	4846	5372	3	105	14 5/8	28 1/4	255
	LG64U-D[P or B]2	4700	5067	5617	4 (2 piece unit)	111	14 5/8	28 1/4	255
	LG64V-D[P or B]2	4905	5288	5862	4 (2 piece unit)	117	14 5/8	28 1/4	265
Veneer species must be noted on each line item [P or B]: indicate P for Satin Pewter/Fog Grey, B for Satin Bronze/Nubian Brown									

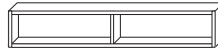
<b>Overhead Cabinets, Garage Mount Open with Melamine Back</b>									
	LG64M-E[P or B]	1650	1778	1971	2	75	13 3/4	14 1/2	175
	LG64N-E[P or B]	2180	2350	2605	3	81	13 3/4	14 1/2	195
	LG64P-E[P or B]	2375	2560	2838	3	87	13 3/4	14 1/2	195
	LG64R-E[P or B]	2560	2760	3059	3	93	13 3/4	14 1/2	205
	LG64S-E[P or B]	2765	2981	3304	3	99	13 3/4	14 1/2	205
	LG64T-E[P or B]	2845	3067	3400	3	105	13 3/4	14 1/2	215
	LG64U-E[P or B]	3145	3390	3758	4 (2 piece unit)	111	13 3/4	14 1/2	215
	LG64V-E[P or B]	3310	3568	3955	4 (2 piece unit)	117	13 3/4	14 1/2	225
Veneer species must be noted on each line item [P or B]: indicate P for Satin Pewter/Fog Grey, B for Satin Bronze/Nubian Brown									

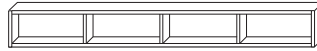
<b>Overhead Cabinets, Garage Mount Open with Wood Back</b>									
	LG64M-E	1905	2053	2276		75	13 3/4	14 1/2	175
	LG64N-E	2435	2625	2910		81	13 3/4	14 1/2	195
	LG64P-E	2630	2835	3143		87	13 3/4	14 1/2	195
	LG64R-E	2815	3035	3364		93	13 3/4	14 1/2	205
	LG64S-E	3020	3256	3609		99	13 3/4	14 1/2	205
	LG64T-E	3105	3347	3710		105	13 3/4	14 1/2	215
	LG64U-E	3400	3665	4063		111	13 3/4	14 1/2	215
	LG64V-E	3565	3843	4260		117	13 3/4	14 1/2	225
Veneer species must be noted on each line item									

Due to the depth of door hardware, end doors on LOGICwork overhead units are hinged to open inward in order to prevent damage to adjacent vertical storage units or wall.



Veneer species must be noted on each line item

Veneer Grade 1	Veneer Grade 2	Veneer Grade 3
Cherry	Rift Oak	Anigre
Maple	Sapele	
Ligno-Grain		
Walnut		

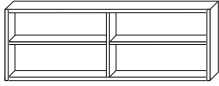
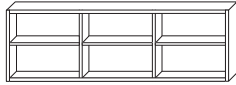
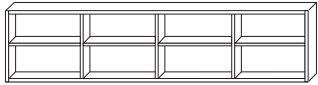
# HBF LOGICwork Overhead Cabinets

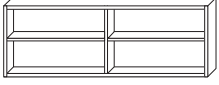
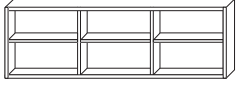
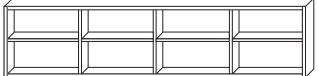
Style Number	Fabric	List Price			Number of Doors	Dimensions			Weight
		Veneer 1	Veneer 2	Veneer 3		OW	OD	OH	
<b>Overhead Cabinets, Garage Mount Open with Melamine Back (Double High)</b>									
	LG64M-E[P or B]2		2395	2582	2862	75	13 3/4	28 1/4	195
	LG64N-E[P or B]2		2960	3191	3537	81	13 3/4	28 1/4	215
	LG64P-E[P or B]2		3175	3423	3794	87	13 3/4	28 1/4	215
	LG64R-E[P or B]2		3370	3633	4027	93	13 3/4	28 1/4	225
	LG64S-E[P or B]2		3575	3854	4272	99	13 3/4	28 1/4	225
	LG64T-E[P or B]2		3780	4075	4517	105	13 3/4	28 1/4	235
	LG64U-E[P or B]2		3985	4296	4762	111	13 3/4	28 1/4	235
	LG64V-E[P or B]2		4190	4517	5007	117	13 3/4	28 1/4	245
Veneer species must be noted on each line item [P or B]: indicate P for Satin Pewter/Fog Grey, B for Satin Bronze/Nubian Brown									

<b>Overhead Cabinets, Garage Mount Open with Wood Back (Double High)</b>									
	LG64M-E2		2650	2857	3167	75	13 3/4	28 1/4	195
	LG64N-E2		3215	3466	3842	81	13 3/4	28 1/4	215
	LG64P-E2		3430	3968	4099	87	13 3/4	28 1/4	215
	LG64R-E2		3625	3908	4332	93	13 3/4	28 1/4	225
	LG64S-E2		3830	4129	4577	99	13 3/4	28 1/4	225
	LG64T-E2		4035	4350	4822	105	13 3/4	28 1/4	235
	LG64U-E2		4240	4571	5067	111	13 3/4	28 1/4	235
	LG64V-E2		4445	4792	5312	117	13 3/4	28 1/4	245
Veneer species must be noted on each line item									



<b>Overhead Shelves, Garage Mount Half High Open with Wood Back</b>									
	LG64M-F		805	868	962	75	13 3/4	6	125
	LG64N-F		910	981	1087	81	13 3/4	6	145
	LG64P-F		1000	1078	1195	87	13 3/4	6	145
	LG64R-F		1115	1202	1332	93	13 3/4	6	155
	LG64S-F		1225	1321	1464	99	13 3/4	6	155
	LG64T-F		1330	1434	1589	105	13 3/4	6	165
	LG64U-F		1465	1579	1750	111	13 3/4	6	165
	LG64V-F		1635	1763	1954	117	13 3/4	6	175
Veneer species must be noted on each line item									

Due to the depth of door hardware, end doors on LOGICwork overhead units are hinged to open inward in order to prevent damage to adjacent vertical storage units or wall.

Veneer species must be noted on each line item

Veneer Grade 1	Veneer Grade 2	Veneer Grade 3
Cherry	Rift Oak	Anigre
Maple	Sapele	
Ligno-Grain		
Walnut		

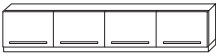
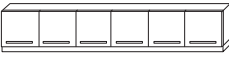
# HBF LOGICwork Overhead Cabinets



Style Number	Fabric	List Price			Number of Doors	Dimensions			Weight	
		Veneer 1	Veneer 2	Veneer 3		OW	OD	OH		
<b>Overhead Cabinets, Wall Mount with Hinged Wood Doors and Melamine Back</b>										
	LG65M-A[P or B]	2-1/2 yds.	3235	3487	3866	4	72	15 1/2	16 3/8	195
	LG65N-A[P or B]	3 yds.	3770	4064	4505	6	78	15 1/2	16 3/8	215
	LG65P-A[P or B]	3 yds.	3965	4274	4738	6	84	15 1/2	16 3/8	215
	LG65R-A[P or B]	3 yds.	4150	4474	4959	6	90	15 1/2	16 3/8	225
	LG65S-A[P or B]	3-1/4 yds.	4355	4695	5204	6	96	15 1/2	16 3/8	225
	LG65T-A[P or B]	3-1/2 yds.	4435	4781	5300	6	102	15 1/2	16 3/8	235
	LG65U-A[P or B]	3-3/4 yds.	4735	5104	5658	8 (2 piece unit)	108	15 1/2	16 3/8	235
	LG65V-A[P or B]	4-1/4 yds.	4895	5277	5850	8 (2 piece unit)	114	15 1/2	16 3/8	245

Veneer species must be noted on each line item

[P or B]: indicate P for Satin Pewter/Fog Grey, B for Satin Bronze/Nubian Brown

Note: Wall mount overheads include a wall mount tackpanel.

## Overhead Cabinets, Wall Mount with Hinged Wood Doors and Melamine Back (Double High)



	LG65M-A[P or B]2	2-1/2 yds.	4345	4684	5192	4	72	15 1/2	30 1/8	220
	LG65N-A[P or B]2	3 yds.	4905	5288	5862	6	78	15 1/2	30 1/8	240
	LG65P-A[P or B]2	3 yds.	5120	5520	6119	6	84	15 1/2	30 1/8	240
	LG65R-A[P or B]2	3 yds.	5315	5730	6352	6	90	15 1/2	30 1/8	250
	LG65S-A[P or B]2	3-1/4 yds.	5520	5951	6597	6	96	15 1/2	30 1/8	250
	LG65T-A[P or B]2	3-1/2 yds.	5725	6172	6842	6	102	15 1/2	30 1/8	260
	LG65U-A[P or B]2	3-3/4 yds.	5930	6393	7087	8 (2 piece unit)	108	15 1/2	30 1/8	260
	LG65V-A[P or B]2	4-1/4 yds.	6135	6614	7332	8 (2 piece unit)	114	15 1/2	30 1/8	270

Veneer species must be noted on each line item

[P or B]: indicate P for Satin Pewter/Fog Grey, B for Satin Bronze/Nubian Brown

Note: Wall mount overheads include a wall mount tackpanel.

## Overhead Cabinets, Wall Mount with Half High Hinged Wood Doors and Wood Back (Double High)

	LG65M-C2	2-1/2 yds.	4240	4571	5067	4	72	15 1/2	30 1/8	215
	LG65N-C2	3 yds.	4805	5180	5742	6	78	15 1/2	30 1/8	235
	LG65P-C2	3 yds.	5020	5412	5999	6	84	15 1/2	30 1/8	235
	LG65R-C2	3 yds.	5215	5622	6232	6	90	15 1/2	30 1/8	245
	LG65S-C2	3-1/4 yds.	5420	5843	6477	6	96	15 1/2	30 1/8	245
	LG65T-C2	3-1/2 yds.	5625	6064	6722	6	102	15 1/2	30 1/8	255
	LG65U-C2	3-3/4 yds.	5830	6285	6967	8 (2 piece unit)	108	15 1/2	30 1/8	255
	LG65V-C2	4-1/4 yds.	6035	6506	7212	8 (2 piece unit)	114	15 1/2	30 1/8	265

Veneer species must be noted on each line item

Note: Wall mount overheads include a wall mount tackpanel.

Single high and double high wall mounted overhead cabinets to be used with corresponding height wall mounted vertical cabinets. Proper installation of wall mounted overhead cabinets is the sole responsibility of the customer and is crucial to prevent personal injury.

Due to the depth of door hardware, end doors on LOGICwork overhead units are hinged to open inward in order to prevent damage to adjacent vertical storage units or wall.

Veneer species must be noted on each line item

Veneer Grade 1	Veneer Grade 2	Veneer Grade 3
Cherry	Rift Oak	Anigre
Maple	Sapele	
Ligno-Grain		
Walnut		

# HBF LOGICwork

## Overhead Cabinets

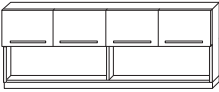
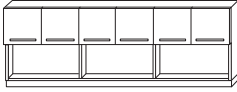
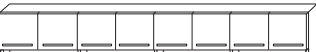
Style Number	Fabric	List Price			Number of Doors	Dimensions			Weight	
		Veneer 1	Veneer 2	Veneer 3		OW	OD	OH		
<b>Overhead Cabinets, Wall Mount with Half High Hinged Wood Doors and Melamine Back (Double High)</b>										
	LG65M-C[P or B]2A	2-1/2 yds.	3985	4296	4762	4	72	15 1/2	30 1/8	215
	LG65N-C[P or B]2A	3 yds.	4550	4905	5437	6	78	15 1/2	30 1/8	235
	LG65P-C[P or B]2A	3 yds.	4765	5137	5694	6	84	15 1/2	30 1/8	235
	LG65R-C[P or B]2A	3 yds.	4960	5347	5927	6	90	15 1/2	30 1/8	245
	LG65S-C[P or B]2A	3-1/4 yds.	5165	5568	6172	6	96	15 1/2	30 1/8	245
	LG65T-C[P or B]2A	3-1/2 yds.	5370	5789	6417	6	102	15 1/2	30 1/8	255
	LG65U-C[P or B]2A	3-3/4 yds.	5575	6010	6662	8 (2 piece unit)	108	15 1/2	30 1/8	255
	LG65V-C[P or B]2A	4-1/4 yds.	5780	6231	6907	8 (2 piece unit)	114	15 1/2	30 1/8	265

Veneer species must be noted on each line item

[P or B]: indicate P for Satin Pewter/Fog Grey, B for Satin Bronze/Nubian Brown

Note: Wall mount overheads include a wall mount tackpanel.

### Overhead Cabinets, Wall Mount with Wood Flipper Doors and Melamine Back

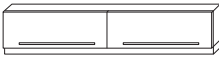
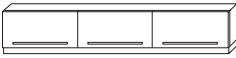
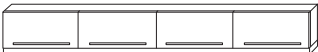
	LG65M-B[P or B]	2-1/2 yds.	3235	3487	3866	2	72	15 1/2	16 3/8	195
	LG65N-B[P or B]	3 yds.	3770	4064	4505	3	78	15 1/2	16 3/8	215
	LG65P-B[P or B]	3 yds.	3965	4274	4738	3	84	15 1/2	16 3/8	215
	LG65R-B[P or B]	3 yds.	4150	4474	4959	3	90	15 1/2	16 3/8	225
	LG65S-B[P or B]	3-1/4 yds.	4355	4695	5204	3	96	15 1/2	16 3/8	225
	LG65T-B[P or B]	3-1/2 yds.	4435	4781	5300	3	102	15 1/2	16 3/8	235
	LG65U-B[P or B]	3-3/4 yds.	4735	5104	5658	4 (2 piece unit)	108	15 1/2	16 3/8	235
	LG65V-B[P or B]	4-1/4 yds.	4895	5277	5850	4 (2 piece unit)	114	15 1/2	16 3/8	245

Veneer species must be noted on each line item

[P or B]: indicate P for Satin Pewter/Fog Grey, B for Satin Bronze/Nubian Brown

Note: Wall mount overheads include a wall mount tackpanel.

### Overhead Cabinets, Wall Mount Half High with Wood Flipper Doors and Wood Back (Double High)

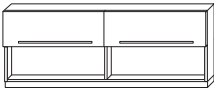
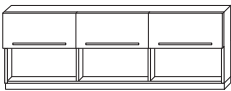
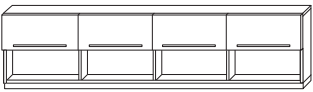
	LG65M-D2	2-1/2 yds.	4240	4571	5067	2	72	15 1/2	30 1/8	215
	LG65N-D2	3 yds.	4805	5180	5742	3	78	15 1/2	30 1/8	235
	LG65P-D2	3 yds.	5020	5412	5999	3	84	15 1/2	30 1/8	235
	LG65R-D2	3 yds.	5215	5622	6232	3	90	15 1/2	30 1/8	245
	LG65S-D2	3-1/4 yds.	5420	5843	6477	3	96	15 1/2	30 1/8	245
	LG65T-D2	3-1/2 yds.	5625	6064	6722	3	102	15 1/2	30 1/8	255
	LG65U-D2	3-3/4 yds.	5830	6285	6967	4 (2 piece unit)	108	15 1/2	30 1/8	255
	LG65V-D2	4-1/4 yds.	6035	6506	7212	4 (2 piece unit)	114	15 1/2	30 1/8	265

Veneer species must be noted on each line item

Note: Wall mount overheads include a wall mount tackpanel.

Single high and double high wall mounted overhead cabinets to be used with corresponding height wall mounted vertical cabinets. Proper installation of wall mounted overhead cabinets is the sole responsibility of the customer and is crucial to prevent personal injury.

Due to the depth of door hardware, end doors on LOGICwork overhead units are hinged to open inward in order to prevent damage to adjacent vertical storage units or wall.

Veneer species must be noted on each line item

Veneer Grade 1	Veneer Grade 2	Veneer Grade 3
Cherry	Rift Oak	Anigre
Maple	Sapele	
Ligno-Grain		
Walnut		

# HBF LOGICwork Overhead Cabinets

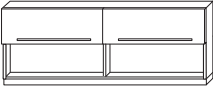
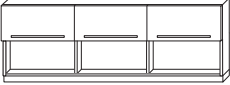
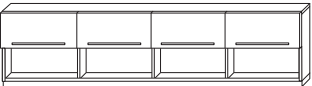
Style Number	Fabric	List Price			Number of Doors	Dimensions			Weight	
		Veneer 1	Veneer 2	Veneer 3		OW	OD	OH		
<b>Overhead Cabinets, Wall Mount with Half High Wood Flipper Doors and Melamine Back (Double High)</b>										
	LG65M-D[P or B]2	2-1/2 yds.	3985	4296	4762	2	72	15 1/2	30 1/8	215
	LG65N-D[P or B]2	3 yds.	4550	4905	5437	3	78	15 1/2	30 1/8	235
	LG65P-D[P or B]2	3 yds.	4765	5137	5694	3	84	15 1/2	30 1/8	235
	LG65R-D[P or B]2	3 yds.	4960	5347	5927	3	90	15 1/2	30 1/8	245
	LG65S-D[P or B]2	3-1/4 yds.	5165	5568	6172	3	96	15 1/2	30 1/8	245
	LG65T-D[P or B]2	3-1/2 yds.	5370	5789	6417	3	102	15 1/2	30 1/8	255
	LG65U-D[P or B]2	3-3/4 yds.	5575	6010	6662	4 (2 piece unit)	108	15 1/2	30 1/8	255
	LG65V-D[P or B]2	4-1/4 yds.	5780	6231	6907	4 (2 piece unit)	114	15 1/2	30 1/8	265
Veneer species must be noted on each line item										
[P or B]: indicate P for Satin Pewter/Fog Grey, B for Satin Bronze/Nubian Brown										
Note: Wall mount overheads include a wall mount tackpanel.										

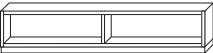
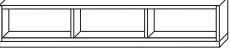
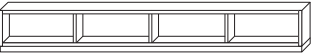
<b>Overhead Cabinets, Wall Mount Open with Melamine Back</b>										
	LG65M-E[P or B]	2-1/2 yds.	2520	2716	3011	2	72	14 5/8	16 3/8	175
	LG65N-E[P or B]	3 yds.	3050	3288	3645	3	78	14 5/8	16 3/8	195
	LG65P-E[P or B]	3 yds.	3245	3498	3878	3	84	14 5/8	16 3/8	195
	LG65R-E[P or B]	3 yds.	3430	3698	4099	3	90	14 5/8	16 3/8	205
	LG65S-E[P or B]	3-1/4 yds.	3635	3919	4344	3	96	14 5/8	16 3/8	205
	LG65T-E[P or B]	3-1/2 yds.	3720	4010	4445	3	102	14 5/8	16 3/8	215
	LG65U-E[P or B]	3-3/4 yds.	4015	4328	4798	4 (2 piece unit)	108	14 5/8	16 3/8	215
	LG65V-E[P or B]	4-1/4 yds.	4180	4506	4995	4 (2 piece unit)	114	14 5/8	16 3/8	225
Veneer species must be noted on each line item										
[P or B]: indicate P for Satin Pewter/Fog Grey, B for Satin Bronze/Nubian Brown										
Note: Wall mount overheads include a wall mount tackpanel.										

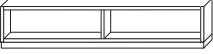
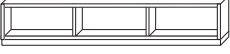
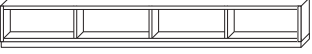
<b>Overhead Cabinets, Wall Mount Open with Wood Back</b>										
	LG65M-E	2-1/2 yds.	2775	2991	3316		72	14 5/8	16 3/8	175
	LG65N-E	3 yds.	3310	3568	3955		78	14 5/8	16 3/8	195
	LG65P-E	3 yds.	3505	3778	4188		84	14 5/8	16 3/8	195
	LG65R-E	3 yds.	3685	3973	4404		90	14 5/8	16 3/8	205
	LG65S-E	3-1/4 yds.	3890	4194	4649		96	14 5/8	16 3/8	205
	LG65T-E	3-1/2 yds.	3975	4285	4750		102	14 5/8	16 3/8	215
	LG65U-E	3-3/4 yds.	4270	4603	5103	(2 piece unit)	108	14 5/8	16 3/8	215
	LG65V-E	4-1/4 yds.	4435	4781	5300	(2 piece unit)	114	14 5/8	16 3/8	225
Veneer species must be noted on each line item										
Note: Wall mount overheads include a wall mount tackpanel.										

Single high and double high wall mounted overhead cabinets to be used with corresponding height wall mounted vertical cabinets. Proper installation of wall mounted overhead cabinets is the sole responsibility of the customer and is crucial to prevent personal injury.

Due to the depth of door hardware, end doors on LOGICwork overhead units are hinged to open inward in order to prevent damage to adjacent vertical storage units or wall.



Veneer species must be noted on each line item

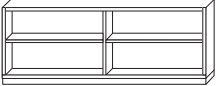
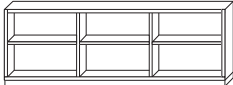
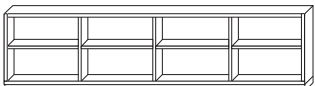

Veneer Grade 1	Veneer Grade 2	Veneer Grade 3
Cherry	Rift Oak	Anigre
Maple	Sapele	
Ligno-Grain		
Walnut		

# HBF LOGICwork

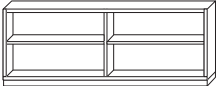
## Overhead Cabinets

Style Number	Fabric	List Price			Number of Doors	Dimensions			Weight	
		Veneer 1	Veneer 2	Veneer 3		OW	OD	OH		
<b>Overhead Cabinets, Wall Mount Open with Melamine Back (Double High)</b>										
	LG65M-E[P or B]2	2-1/2 yds.	3265	3520	3902	72	14 5/8	30 1/8	195	
	LG65N-E[P or B]2	3 yds.	3830	4129	4577	78	14 5/8	30 1/8	215	
	LG65P-E[P or B]2	3 yds.	4045	4361	4834	84	14 5/8	30 1/8	215	
	LG65R-E[P or B]2	3 yds.	4240	4571	5067	90	14 5/8	30 1/8	225	
	LG65S-E[P or B]2	3-1/4 yds.	4445	4792	5312	96	14 5/8	30 1/8	225	
	LG65T-E[P or B]2	3-1/2 yds.	4650	5013	5557	102	14 5/8	30 1/8	235	
	LG65U-E[P or B]2	3-3/4 yds.	4855	5234	5802	(2 piece unit)	108	14 5/8	30 1/8	235
	LG65V-E[P or B]2	4-1/4 yds.	5060	5455	6047	(2 piece unit)	114	14 5/8	30 1/8	245
Veneer species must be noted on each line item										
[P or B]: indicate P for Satin Pewter/Fog Grey, B for Satin Bronze/Nubian Brown										
Note: Wall mount overheads include a wall mount tackpanel.										

<b>Overhead Cabinets, Wall Mount Open with Wood Back (Double High)</b>										
	LG65M-E2	2-1/2 yds.	3525	3800	4212	72	14 5/8	30 1/8	195	
	LG65N-E2	3 yds.	4085	4404	4882	78	14 5/8	30 1/8	215	
	LG65P-E2	3 yds.	4300	4636	5139	84	14 5/8	30 1/8	215	
	LG65R-E2	3 yds.	4495	4846	5372	90	14 5/8	30 1/8	225	
	LG65S-E2	3-1/4 yds.	4700	5067	5617	96	14 5/8	30 1/8	225	
	LG65T-E2	3-1/2 yds.	4905	5288	5862	102	14 5/8	30 1/8	235	
	LG65U-E2	3-3/4 yds.	5110	5509	6107	(2 piece unit)	108	14 5/8	30 1/8	235
	LG65V-E2	4-1/4 yds.	5315	5730	6352	(2 piece unit)	114	14 5/8	30 1/8	245
Veneer species must be noted on each line item										
Note: Wall mount overheads include a wall mount tackpanel.										

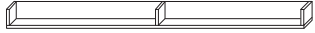
<b>Overhead Shelves, Half High Open with Wood Back</b>										
	LG65M-F		805	868	962	72	14 5/8	6	125	
	LG65N-F		910	981	1087	78	14 5/8	6	145	
	LG65P-F		1000	1078	1195	84	14 5/8	6	145	
	LG65R-F		1115	1202	1332	90	14 5/8	6	155	
	LG65S-F		1225	1321	1464	96	14 5/8	6	155	
	LG65T-F		1330	1434	1589	102	14 5/8	6	165	
	LG65U-F		1465	1579	1750	(2 piece unit)	108	14 5/8	6	165
	LG65V-F		1635	1763	1954	(2 piece unit)	114	14 5/8	6	175
Veneer species must be noted on each line item										
Note: NOT a wall mounted unit. For use above a wall mount.										

Single high and double high wall mounted overhead cabinets to be used with corresponding height wall mounted vertical cabinets. Proper installation of wall mounted overhead cabinets is the sole responsibility of the customer and is crucial to prevent personal injury.

Due to the depth of door hardware, end doors on LOGICwork overhead units are hinged to open inward in order to prevent damage to adjacent vertical storage units or wall.

Veneer species must be noted on each line item

Veneer Grade 1	Veneer Grade 2	Veneer Grade 3
Cherry	Rift Oak	Anigre
Maple	Sapele	
Ligno-Grain		
Walnut		

# HBF LOGICwork

## Vertical Storage

Style Number	List Price			Dimensions			
	Veneer 1	Veneer 2	Veneer 3	OW	OD	OH	Weight

### Vertical Storage Cabinets

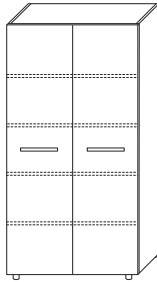

<b>LG70M</b>	<b>3685</b>	<b>3973</b>	<b>4404</b>	30	25 3/4	67	205
<b>LG70N</b>	<b>3850</b>	<b>4150</b>	<b>4601</b>	36	25 3/4	67	237

**Veneer species must be noted on each line item**

Storage unit, two doors, four adjustable shelves, cabinet back unfinished.

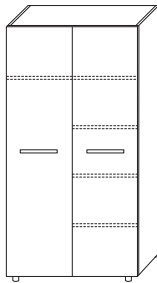

<b>LG71M</b>	<b>3945</b>	<b>4253</b>	<b>4714</b>	30	25 3/4	67	205
<b>LG71N</b>	<b>4085</b>	<b>4404</b>	<b>4882</b>	36	25 3/4	67	237

**Veneer species must be noted on each line item**

Storage/wardrobe unit, two doors, four adjustable shelves and a hat shelf with wardrobe rod, shelves are field changeable from left to right, cabinet back unfinished.

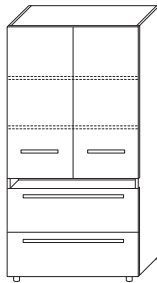

<b>LG72M</b>	<b>4505</b>	<b>4857</b>	<b>5384</b>	30	25 3/4	67	235
<b>LG72N</b>	<b>4650</b>	<b>5013</b>	<b>5557</b>	36	25 3/4	67	267

**Veneer species must be noted on each line item**

Storage unit, two doors and two adjustable shelves above and two locking lateral file drawers below. Cabinet back unfinished.



<b>LG73M</b>	<b>4170</b>	<b>4495</b>	<b>4983</b>	30	25 3/4	67	225
<b>LG73N</b>	<b>4335</b>	<b>4673</b>	<b>5180</b>	36	25 3/4	67	257

**Veneer species must be noted on each line item**

Storage unit, open above with two adjustable shelves, two locking lateral file drawers below. Cabinet back unfinished.

**Veneer species must be noted on each line item**

<u>Veneer Grade 1</u>	<u>Veneer Grade 2</u>	<u>Veneer Grade 3</u>
Cherry	Rift Oak	Anigre
Maple	Sapele	
Ligno-Grain		
Walnut		

# HBF LOGICwork

## Vertical Storage

Style Number		List Price			Dimensions			
		Veneer 1	Veneer 2	Veneer 3	OW	OD	OH	Weight

### Vertical Storage Cabinets

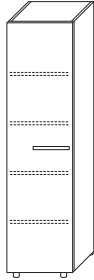

<b>LGLH70P</b>	(left hinge)	<b>3050</b>	<b>3288</b>	<b>3645</b>	18	25 3/4	67	176
<b>LGRH70P</b>	(right hinge)	<b>3050</b>	<b>3288</b>	<b>3645</b>	18	25 3/4	67	176

**Veneer species must be noted on each line item**

Storage unit, single door, four adjustable shelves. Cabinet back unfinished.

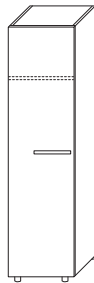

<b>LGLH71P</b>	(left hinge)	<b>2825</b>	<b>3045</b>	<b>3376</b>	18	25 3/4	67	166
<b>LGRH71P</b>	(right hinge)	<b>2825</b>	<b>3045</b>	<b>3376</b>	18	25 3/4	67	166

**Veneer species must be noted on each line item**

Wardrobe unit single door, hat shelf and wardrobe rod. Cabinet back unfinished.

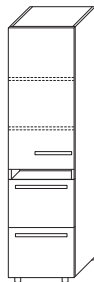

<b>LGLH72P</b>	(left hinge)	<b>3740</b>	<b>4032</b>	<b>4469</b>	18	25 3/4	67	196
<b>LGRH72P</b>	(right hinge)	<b>3740</b>	<b>4032</b>	<b>4469</b>	18	25 3/4	67	196

**Veneer species must be noted on each line item**

Storage unit, single door and two adjustable shelves above and two locking file drawers below. Cabinet back unfinished.

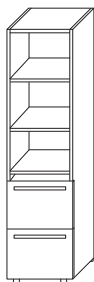

<b>LG73P</b>		<b>3205</b>	<b>3455</b>	<b>3830</b>	18	25 3/4	67	186
--------------	--	-------------	-------------	-------------	----	--------	----	-----

**Veneer species must be noted on each line item**

Storage unit, two open adjustable shelves above, two locking file drawers below. Cabinet back unfinished.

**Veneer species must be noted on each line item**

<u>Veneer Grade 1</u>	<u>Veneer Grade 2</u>	<u>Veneer Grade 3</u>
Cherry	Rift Oak	Anigre
Maple	Sapele	
Ligno-Grain		
Walnut		

# HBF LOGICwork

## Vertical Storage

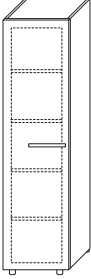
Style Number	List Price			Dimensions				
	Veneer 1	Veneer 2	Veneer 3	OW	OD	OH	Weight	
<b>Vertical Storage Cabinets</b>								
	LGLH74P (open on right)	3450	3719	4123	18	25 3/4	67	235
	LGRH74P (open on left)	3450	3719	4123	18	25 3/4	67	235

Veneer species must be noted on each line item

Pantry unit, pullout bookcase with four adjustable shelves. Cabinet back unfinished.

**Note: Due to pullout function, pantry case must be attached to wall to ensure stability. Proper installation is the sole responsibility of the customer and is crucial to prevent personal injury.**

### Vertical Storage Cabinets (Double High)

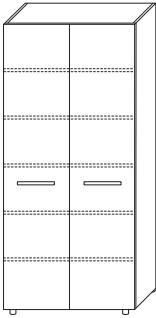
	LG70M2	5030	5422	6011	30	25 3/4	80 3/4	277
	LG70N2	5245	5654	6268	36	25 3/4	80 3/4	320

Veneer species must be noted on each line item

Storage unit, two doors, five adjustable shelves, cabinet back unfinished.

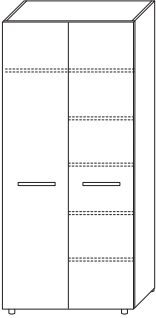
	LG71M2	5370	5789	6417	30	25 3/4	80 3/4	277
	LG71N2	5575	6010	6662	36	25 3/4	80 3/4	320

Veneer species must be noted on each line item

Storage/wardrobe unit, two doors, five adjustable shelves and a hat shelf with wardrobe rod, shelves are field changeable from left to right, cabinet back unfinished.

### Veneer species must be noted on each line item

<u>Veneer Grade 1</u>	<u>Veneer Grade 2</u>	<u>Veneer Grade 3</u>
Cherry	Rift Oak	Anigre
Maple	Sapele	
Ligno-Grain		
Walnut		

# HBF LOGICwork

## Vertical Storage

Style Number	List Price			Dimensions			
	Veneer 1	Veneer 2	Veneer 3	OW	OD	OH	Weight

### Vertical Storage Cabinets (Double High)

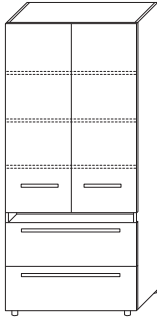

<b>LG72M2</b>	<b>6145</b>	<b>6625</b>	<b>7344</b>	30	25 3/4	80 3/4	307
<b>LG72N2</b>	<b>6330</b>	<b>6824</b>	<b>7565</b>	36	25 3/4	80 3/4	350

**Veneer species must be noted on each line item**

Storage unit, two doors and three adjustable shelves above, two locking lateral file drawers below. Cabinet back unfinished.

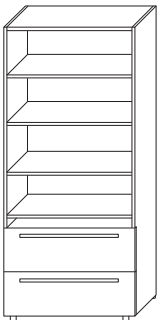

<b>LG73M2</b>	<b>5675</b>	<b>6118</b>	<b>6782</b>	30	25 3/4	80 3/4	297
<b>LG73N2</b>	<b>5900</b>	<b>6360</b>	<b>7051</b>	36	25 3/4	80 3/4	240

**Veneer species must be noted on each line item**

Storage unit, three open adjustable shelves above and two locking lateral file drawers below. Cabinet back unfinished.

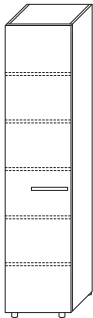

<b>LGLH70P2</b>	(left hinge)	<b>4150</b>	<b>4474</b>	<b>4959</b>	18	25 3/4	80 3/4	237
<b>LGRH70P2</b>	(right hinge)	<b>4150</b>	<b>4474</b>	<b>4959</b>	18	25 3/4	80 3/4	237

**Veneer species must be noted on each line item**

Storage unit, single door, five adjustable shelves. Cabinet back unfinished.

**Veneer species must be noted on each line item**

<b><u>Veneer Grade 1</u></b>	<b><u>Veneer Grade 2</u></b>	<b><u>Veneer Grade 3</u></b>
Cherry	Rift Oak	Anigre
Maple	Sapele	
Ligno-Grain		
Walnut		

# HBF LOGICwork

## Vertical Storage

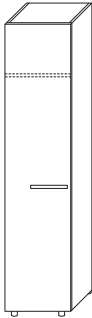
Style Number		List Price			Dimensions			
		Veneer 1	Veneer 2	Veneer 3	OW	OD	OH	Weight
	<b>LGLH71P2</b> (left hinge)	<b>3850</b>	<b>4150</b>	<b>4601</b>	18	25 3/4	80 3/4	227
	<b>LGRH71P2</b> (right hinge)	<b>3850</b>	<b>4150</b>	<b>4601</b>	18	25 3/4	80 3/4	227

**Veneer species must be noted on each line item**

Wardrobe unit, single door, hat shelf and wardrobe rod. Cabinet back unfinished.

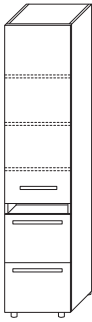
	<b>LGLH72P2</b> (left hinge)	<b>5090</b>	<b>5487</b>	<b>6083</b>	18	25 3/4	80 3/4	267
	<b>LGRH72P2</b> (right hinge)	<b>5090</b>	<b>5487</b>	<b>6083</b>	18	25 3/4	80 3/4	267

**Veneer species must be noted on each line item**

Storage unit, single door and three adjustable shelves above, two locking file drawers below. Cabinet back unfinished.

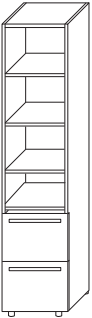
	<b>LG73P2</b>	<b>4375</b>	<b>4716</b>	<b>5228</b>	18	25 3/4	80 3/4	257
---	---------------	-------------	-------------	-------------	----	--------	--------	-----

**Veneer species must be noted on each line item**

Storage unit, three open adjustable shelves above and two locking file drawers below. Cabinet back unfinished.

**Veneer species must be noted on each line item**

<u>Veneer Grade 1</u>	<u>Veneer Grade 2</u>	<u>Veneer Grade 3</u>
Cherry	Rift Oak	Anigre
Maple	Sapele	
Ligno-Grain		
Walnut		

# HBF LOGICwork

## Vertical Storage

Style Number		List Price			Dimensions			Weight
		Veneer 1	Veneer 2	Veneer 3	OW	OD	OH	
<b>Vertical Storage Cabinets (Double High)</b>								
<b>LGLH74P2</b>	(open on right)	<b>4690</b>	<b>5056</b>	<b>5605</b>	18	25 3/4	80 3/4	245
<b>LGRH74P2</b>	(open on left)	<b>4690</b>	<b>5056</b>	<b>5605</b>	18	25 3/4	80 3/4	245

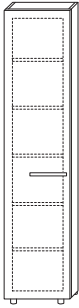

**Veneer species must be noted on each line item**

Pantry unit, pullout bookcase with five adjustable shelves. Flush top without profile edge detail, cabinet back unfinished.

**Note: Due to pullout function, pantry case must be attached to wall to ensure stability. Proper installation is the sole responsibility of the customer and is crucial to prevent personal injury.**

**Veneer species must be noted on each line item**

<u>Veneer Grade 1</u>	<u>Veneer Grade 2</u>	<u>Veneer Grade 3</u>
Cherry	Rift Oak	Anigre
Maple	Sapele	
Ligno-Grain		
Walnut		

# HBF LOGICwork

## Bookcases

Style Number	List Price				Dimensions			
	Veneer 1	Veneer 2	Veneer 3		OW	OD	OH	Weight

### Bookcases

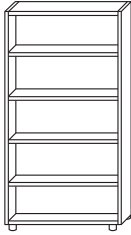

<b>LG75MB</b>	<b>2900</b>	<b>3126</b>	<b>3465</b>	30	13 3/4	67	195
<b>LG75NB</b>	<b>2960</b>	<b>3191</b>	<b>3537</b>	36	13 3/4	67	227

**Veneer species must be noted on each line item**

Four adjustable shelves, standard black unfinished back panel.

Note: Bookcases must be attached to wall to ensure stability. Proper installation is the sole responsibility of the customer and is crucial to prevent personal injury.

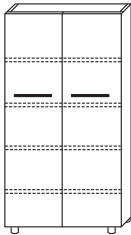

<b>LG76MB</b>	<b>3125</b>	<b>3369</b>	<b>3734</b>	30	14 5/8	67	205
<b>LG76NB</b>	<b>3245</b>	<b>3498</b>	<b>3878</b>	36	14 5/8	67	237

**Veneer species must be noted on each line item**

Two doors, four adjustable shelves, standard black unfinished back panel.

Note: Bookcases must be attached to wall to ensure stability. Proper installation is the sole responsibility of the customer and is crucial to prevent personal injury.

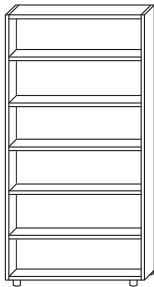

<b>LG75MB2</b>	<b>3935</b>	<b>4242</b>	<b>4702</b>	30	13 3/4	80 3/4	264
<b>LG75NB2</b>	<b>4005</b>	<b>4317</b>	<b>4786</b>	36	13 3/4	80 3/4	307

**Veneer species must be noted on each line item**

Five adjustable shelves, standard black unfinished back panel.

Note: Bookcases must be attached to wall to ensure stability. Proper installation is the sole responsibility of the customer and is crucial to prevent personal injury.

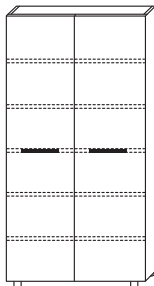

<b>LG76MB2</b>	<b>4230</b>	<b>4560</b>	<b>5055</b>	30	14 5/8	80 3/4	277
<b>LG76NB2</b>	<b>4405</b>	<b>4749</b>	<b>5264</b>	36	14 5/8	80 3/4	320

**Veneer species must be noted on each line item**

Two doors, five adjustable shelves, standard black unfinished back panel.

Note: Bookcases must be attached to wall to ensure stability. Proper installation is the sole responsibility of the customer and is crucial to prevent personal injury.

**Veneer species must be noted on each line item**

<u>Veneer Grade 1</u>	<u>Veneer Grade 2</u>	<u>Veneer Grade 3</u>
Cherry	Rift Oak	Anigre
Maple	Sapele	
Ligno-Grain		
Walnut		

# HBF LOGICwork

## Freestanding Desks

- LOGICwork desks are available in four top shapes
- Wood pedestals can be specified with wood or acrylic drawer fronts
- Metal pedestals can be specified with metal, wood or acrylic drawer fronts
- LOGICwork desks are specified by component: Desktops, pedestals, end panels and modesty panels

### Desk Top Shapes



Rectangular

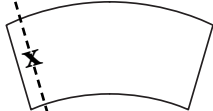

Arc (x = Worksurface Depth)

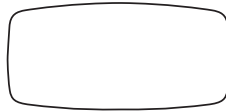

Arched Boat

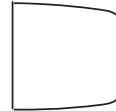

Half Arched Boat

Style Number	List Price			Dimensions			Worksurface Depth (x)	Weight
	Veneer 1	Veneer 2	Veneer 3	OW	OD	OH		
<b>Rectangular Desk Top, Edge Profile 4 Sides</b>								
LG01A	1560	1682	1864	70 3/4	30			85
LG01D	1665	1795	1989	76 3/4	30			95
LG01C	1665	1795	1989	70 3/4	36			95
LG01F	1765	1903	2109	76 3/4	36			105
LG01G	2165	2334	2587	82 3/4	36			110

Veneer species must be noted on each line item

### Arc Desk Top, Edge Profile 4 sides

LG04A	2985	3218	3567	83 1/2	35 3/4		x = 30	90
LG04C	3065	3304	3663	87 1/2	41 3/4		x = 36	100
LG04D	3015	3250	3603	91	36 1/2		x = 30	110
LG04F	3100	3342	3704	95 1/2	42 1/2		x = 36	125

Veneer species must be noted on each line item

### Arched Boat Desk Top, Edge Profile 4 Sides

LG06A	3370	3633	4027	88 3/4	34			90
LG06C	3450	3719	4123	94 3/4	34			100
LG06D	3400	3665	4063	88 3/4	40			110
LG06F	3480	3752	4159	94 3/4	40			125

Veneer species must be noted on each line item

### Half Arched Boat Desk Top, Edge Profile 4 Sides

LG16J	3370	3633	4027	80	34			90
LG16K	3450	3719	4123	86	34			100
LG16L	3400	3665	4063	80	40			110
LG16M	3480	3752	4159	86	40			125

Veneer species must be noted on each line item

### Rectangular Desk Top, Edge Profile 3 Sides

LG11A	1460	1574	1744	68 1/2	30			85
LG11D	1560	1682	1864	74 1/2	30			95
LG11C	1560	1682	1864	68 1/2	36			95
LG11F	1665	1795	1989	74 1/2	36			105
LG11G	2065	2226	2467	80 1/2	36			110

Veneer species must be noted on each line item

Veneer species must be noted on each line item

<u>Veneer Grade 1</u>	<u>Veneer Grade 2</u>	<u>Veneer Grade 3</u>
Cherry	Rift Oak	Anigre
Maple	Sapele	
Ligno-Grain		
Walnut		

# HBF LOGICwork

## Freestanding Desks

Style Number	Description	List Price			Dimensions			
		Veneer 1	Veneer 2	Veneer 3	OW	OD	OH	Weight
<b>Half Arched Boat Desk Top, Edge Profile 3 Sides</b>								
LG16A		3265	3520	3902	77 1/2	34		90
LG16C		3350	3611	4003	83 1/2	34		100
LG16D		3300	3557	3943	77 1/2	40		110
LG16F		3380	3644	4039	83 1/2	40		125

Veneer species must be noted on each line item

### Desk Pedestals, Wood with Wood Drawer Fronts

LG02A	Box/Box/File	1625	1752	1942	18	22 3/4	25 1/2	135
LG02B	File/File	1625	1752	1942	18	22 3/4	25 1/2	135

Veneer species must be noted on each line item

Veneer species must be noted on each line item

### End Panels for Single Pedestal Desks

					OW			
LG[P or B] 02K with Veneer Panel		690	744	824	N/A			48

[P or B]: indicate P for Satin Pewter, B for Satin Bronze

Veneer species must be noted on each line item

LG[P or B] 02L		480	N/A	N/A	N/A			25
----------------	--	-----	-----	-----	-----	--	--	----

[P or B]: indicate P for Satin Pewter, B for Satin Bronze

### Modesty Panels

					OW			
LG02H1	Used with double pedestal desks	420	452	501	Varies			32
LG02H2	Used with single pedestal desks	600	647	717	Varies			41

Veneer species must be noted on each line item

Note: A recessed end panel is used when the side of the single pedestal desk is placed against a wall

### Veneer species must be noted on each line item

Veneer Grade 1	Veneer Grade 2	Veneer Grade 3
Cherry	Rift Oak	Anigre
Maple	Sapele	
Ligno-Grain		
Walnut		

# HBF LOGICwork

## Table Desks

Style Number	List Price			Dimensions				
	Veneer 1	Veneer 2	Veneer 3	OW	OD	OH	Weight	
<b>Rectangular with Panel Bases</b>								
	LG01A-T [P or B]	3555	3832	4248	70 3/4	30	29	220
	LG01C-T [P or B]	3635	3919	4344	70 3/4	36	29	230
	LG01D-T [P or B]	3585	3865	4284	76 3/4	30	29	235
	LG01F-T [P or B]	3665	3951	4380	76 3/4	36	29	245

Veneer species must be noted on each line item  
 [P or B]: indicate P for Satin Pewter, B for Satin Bronze  
 Center drawer standard

<b>Arc with Panel Bases</b>								
	LG04A-T [P or B]	5400	5821	6453	83 1/2	35 3/4	29	240
	LG04C-T [P or B]	5480	5908	6549	87 1/2	41 3/4	29	250
	LG04D-T [P or B]	5430	5854	6489	91	36 1/2	29	255
	LG04F-T [P or B]	5510	5940	6585	95 1/2	42 1/2	29	265

Veneer species must be noted on each line item  
 [P or B]: indicate P for Satin Pewter, B for Satin Bronze  
 Center drawer standard

<b>Arched Boat with Panel Bases</b>								
	LG06A-T [P or B]	5705	6150	6818	88 3/4	34	29	240
	LG06C-T [P or B]	5790	6242	6919	94 3/4	34	29	250
	LG06D-T [P or B]	5735	6183	6854	88 3/4	40	29	255
	LG06F-T [P or B]	5820	6274	6955	94 3/4	40	29	265

Veneer species must be noted on each line item  
 [P or B]: indicate P for Satin Pewter, B for Satin Bronze  
 Center drawer standard

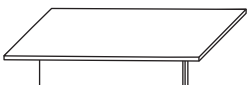
<b>Rectangular with Panel Bases, Modesty Panel</b>								
	LG01A-T [P or B]M	4065	4382	4858	66	30	29	220
	LG01C-T [P or B]M	4150	4474	4959	66	36	29	230
	LG01D-T [P or B]M	4095	4415	4894	72	30	29	235
	LG01F-T [P or B]M	4180	4506	4995	72	36	29	245

Veneer species must be noted on each line item  
 [P or B]: indicate P for Satin Pewter, B for Satin Bronze  
 Center drawer standard

**Veneer species must be noted on each line item**

Veneer Grade 1	Veneer Grade 2	Veneer Grade 3
Cherry	Rift Oak	Anigre
Maple	Sapele	
Ligno-Grain		
Walnut		

# HBF LOGICwork

## Table Desks

Style Number	List Price			Dimensions				
	Veneer 1	Veneer 2	Veneer 3	OW	OD	OH	Weight	
<b>Arc with Panel Bases, Modesty Panel</b>								
	<u>LG04A-T [P or B]M</u>	5910	6371	7063	83 1/2	35 3/4	29	240
	<u>LG04C-T [P or B]M</u>	5995	6463	7164	87 1/2	41 3/4	29	250
	<u>LG04D-T [P or B]M</u>	5940	6404	7099	91	36 1/2	29	255
	<u>LG04F-T [P or B]M</u>	6025	6495	7200	95 1/2	42 1/2	29	265

Veneer species must be noted on each line item

[P or B]: indicate P for Satin Pewter, B for Satin Bronze

Center drawer standard

### Arched Boat with Panel Bases, Modesty Panel

	<u>LG06A-T [P or B]M</u>	6220	6705	7433	88 3/4	34	29	240
	<u>LG06C-T [P or B]M</u>	6300	6792	7529	94 3/4	34	29	250
	<u>LG06D-T [P or B]M</u>	6250	6738	7469	88 3/4	40	29	255
	<u>LG06F-T [P or B]M</u>	6330	6824	7565	94 3/4	40	29	265

Veneer species must be noted on each line item

[P or B]: indicate P for Satin Pewter, B for Satin Bronze

Center drawer standard

Veneer species must be noted on each line item

Veneer Grade 1    Veneer Grade 2    Veneer Grade 3

Cherry	Rift Oak	Anigre
Maple	Sapele	
Ligno-Grain		
Walnut		

# HBF LOGICwork

## Freestanding Credenzas

- LOGICwork freestanding credenzas are specified by components; tops, storage components, end panels and removable access panels
- Credenza tops are available with edge details on 1,2 3 or 4 sides
- Credenza tops specified with edge details on all 4 sides will also include a fixed, finished modesty panel
- OW shown is nominal width, Add 2-1/2" for each end that has edge detail
- The backs of storage components specified for use with a credenza tops with edge details on 1,2 or 3 sides will be black
- OD shown is nominal width, actual width with edge detail is 24-7/8"

### Credenza Tops

#### Style Numbers: Description

<b>LG 31(w)</b>	Edge detail on the front (user) side. All other edges are flat
<b>LG 32(w)</b>	Edge details on the front side and one end
<b>LG 33(w)</b>	Edge details on the front side and both ends
<b>LG 33(w)L</b>	Edge details on front, back and left edge, includes a fixed, finished modesty panel
<b>LG 33(w)R</b>	Edge details on front, back and right edge, includes a fixed, finished modesty panel
<b>LG 34(w)</b>	Edge details on all four sides, includes a fixed, finished modesty panel

Width Codes (w):	Nominal Width	List Price Style Numbers 31, 32, 33			List Price Style Numbers 33(w)L, 33(w)R, 34			Weight
		Veneer 1	Veneer 2	Veneer 3	Veneer 1	Veneer 2	Veneer 3	
M	18	405	437	484	1045	1126	1248	33
N	24	450	485	537	1095	1180	1308	37
P	30	560	604	669	1195	1288	1428	41
R	36	600	647	717	1250	1347	1493	45
S	42	665	717	794	1300	1401	1553	49
A	48	705	760	842	1350	1455	1613	53
B	54	980	1056	1171	1670	1800	1995	57
C	60	1020	1100	1219	1710	1843	2043	61
D	66	1075	1159	1284	1820	1962	2175	65
E	72	1125	1213	1344	1855	1999	2216	70
F	78	1280	1380	1529	2210	2382	2641	75
G	84	1330	1434	1589	2265	2441	2706	80
H	90	1380	1488	1649	2425	2614	2898	85
J	96	1430	1542	1709	2480	2673	2963	90
K	102	1485	1601	1774	2715	2927	3244	96
L	108	1505	1622	1798	2755	2970	3292	102
T	114	1605	1730	1918	2910	3137	3477	108
U	120 (2 piece top)	1625	1752	1942	2940	3169	3513	116
V	126 (2 piece top)	2395	2582	2862	3710	3999	4433	126
W	132 (2 piece top)	2445	2636	2922	3760	4053	4493	136
X	138 (2 piece top)	2500	2695	2987	3810	4107	4553	146



Edge Detail - 1 Edge (**31**)  
Nominal Width = Actual Width  
Actual Depth = 25"  
Standard Black Unfinished Back



Edge Detail - 2 Edges (**32**)  
Nominal Width + 2 1/2" = Actual Width  
Actual Depth = 25"  
Standard Black Unfinished Back



Edge Detail - 3 Edges (**33**)  
Nominal Width + 5" = Actual Width  
Actual Depth = 25"  
Standard Black Unfinished Back



Edge Detail - 3 Edges **33(w)L**  
Nominal Width + 2 1/2" = Actual Width  
Actual Depth = 25"  
Finished Back



Edge Detail - 3 Edges **33(w)R**  
Nominal Width + 2 1/2" = Actual Width  
Actual Depth = 25"  
Finished Back



Edge Detail - 4 Edges (**34**)  
Nominal Width + 5" = Actual Width  
Actual Depth = 25"  
Finished Back

# HBF LOGICwork

## Freestanding Credenzas, Removable Access Panels, End Panels

Style Number	Description	List Price			Dimensions			
		Veneer 1	Veneer 2	Veneer 3	OW	OD	OH	Weight
<b>Credenza Pedestals, Wood Cases with Wood Drawer Fronts</b>								
LG 30A	Box/Box/File	1525	1644	1822	18	20	25 1/2	125
LG 30B	File/File	1525	1644	1822	18	20	25 1/2	125
LG 30C	Lateral File	1835	1978	2193	30	20	25 1/2	140
LG 30D	Lateral File	1945	2097	2324	36	20	25 1/2	140
LG 30UL	Single Door Cabinet	1245	1342	1487	18	20	25 1/2	95
LG 30UR	Single Door Cabinet	1245	1342	1487	18	20	25 1/2	95
LG 30E	Double Door Cabinet	1555	1676	1858	30	20	25 1/2	105
LG 30F	Double Door Cabinet	1585	1709	1894	36	20	25 1/2	110

Veneer species must be noted on each line item

[P or B]: indicate P for Satin Pewter, B for Satin Bronze, cases only

### Removable Access Panel with Wood Face

LG30G1	375	404	448	6"-30"	24
LG30G2	440	474	525	31"-60"	42
LG30G3	805	868	962	61"-90"	60
LG30G4	1095	1180	1308	91"-138"	

Veneer species must be noted on each line item

### Removable Access Panel with Melamine Face

LG[P or B]30G1	275	N/A	N/A	6"-30"	24
LG[P or B]30G2	335	N/A	N/A	31"-60"	42
LG[P or B]30G3	705	N/A	N/A	61"-90"	60
LG[P or B]30G4	990	N/A	N/A	91"-138"	60

[P or B]: indicate P for Satin Pewter, B for Satin Bronze

### End Panels with Veneer Panel

LG[P or B]30K	690	744	824	N/A	45
---------------	-----	-----	-----	-----	----

[P or B]: indicate P for Satin Pewter, B for Satin Bronze

Veneer species must be noted on each line item

LG[P or B]30L	480	N/A	N/A	N/A	22
---------------	-----	-----	-----	-----	----

[P or B]: indicate P for Satin Pewter, B for Satin Bronze

Veneer species must be noted on each line item

Veneer Grade 1	Veneer Grade 2	Veneer Grade 3
Cherry	Rift Oak	Anigre
Maple	Sapele	
Ligno-Grain		
Walnut		

# HBF LOGICwork

## Reception Desks

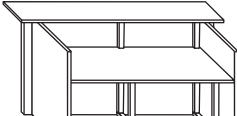
Style Number	List Price			Worksurface Length	Dimensions			Weight	
	Veneer 1	Veneer 2	Veneer 3		OW	OD	OH		
	LG81E[P or B]W-KHK	5840	6296	6979	69 3/4	81 3/4	35 3/4	42	265
	LG81F[P or B]W-KHK	6145	6625	7344	75 3/4	87 3/4	35 3/4	42	280
	LG81G[P or B]W-KHK	6760	7288	8079	81 3/4	93 3/4	35 3/4	42	295
	LG81H[P or B]W-KHK	7070	7622	8449	87 3/4	99 3/4	35 3/4	42	310

Veneer species must be noted on each line item

[P or B]: indicate P for Satin Pewter, B for Satin Bronze

Note: W indicates wood transaction shelf.

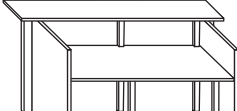
	LG81E[P or B]A-KHK	7070	7622	8449	69 3/4	81 3/4	35 3/4	42	295
	LG81F[P or B]A-KHK	7375	7951	8814	75 3/4	87 3/4	35 3/4	42	310
	LG81G[P or B]A-KHK	7990	8614	9549	81 3/4	93 3/4	35 3/4	42	325
	LG81H[P or B]A-KHK	8300	8948	9919	87 3/4	99 3/4	35 3/4	42	335

Veneer species must be noted on each line item

[P or B]: indicate P for Satin Pewter, B for Satin Bronze

Note: A indicates acrylic solid surface transaction shelf. Specify Alabaster White or Ebony Skies on order.

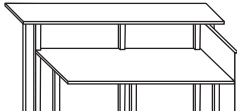
	LG81E[P or B]W-LHK/KHL	5225	5633	6244	69 3/4	81 3/4	35 3/4	42	245
	LG81F[P or B]W-LHK/KHL	5530	5962	6609	75 3/4	87 3/4	35 3/4	42	260
	LG81G[P or B]W-LHK/KHL	6145	6625	7344	81 3/4	93 3/4	35 3/4	42	275
	LG81H[P or B]W-LHK/KHL	6455	6959	7714	87 3/4	99 3/4	35 3/4	42	290

Veneer species must be noted on each line item

[P or B]: indicate P for Satin Pewter, B for Satin Bronze

Note: W indicates wood transaction shelf. LHK indicates finished right-hand. KHL indicates finished left-hand.

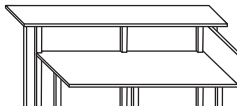
	LG81E[P or B]A-LHK/KHL	6455	6959	7714	69 3/4	81 3/4	35 3/4	42	275
	LG81F[P or B]A-LHK/KHL	6760	7288	8079	75 3/4	87 3/4	35 3/4	42	290
	LG81G[P or B]A-LHK/KHL	7375	7951	8814	81 3/4	93 3/4	35 3/4	42	305
	LG81H[P or B]A-LHK/KHL	7685	8285	9184	87 3/4	99 3/4	35 3/4	42	315

Veneer species must be noted on each line item

[P or B]: indicate P for Satin Pewter, B for Satin Bronze

Note: A indicates acrylic solid surface transaction shelf. Specify Alabaster White or Ebony Skies on order.

LHK indicates finished right-hand. KHL indicates finished left-hand.

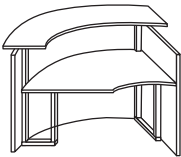
	LG82[P or B]W-LHK/KHL	4355	4695	5204		54 3/8	64 1/4	42	195
	LG82[P or B]A-LHK/KHL	5995	6463	7164		54 3/8	64 1/4	42	225

Veneer species must be noted on each line item

[P or B]: indicate P for Satin Pewter, B for Satin Bronze

Note: W indicates wood transaction shelf.

A indicates acrylic solid surface transaction shelf. Specify Alabaster White or Ebony Skies on order.

LHK indicates finished right-hand. KHL indicates finished left-hand.

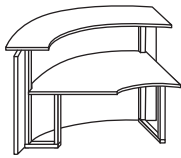
	LG82[P or B]W-LHL	3585	3865	4284		54 3/8	64 1/4	42	175
	LG82[P or B]A-LHL	5225	5633	6244		54 3/8	64 1/4	42	205

Veneer species must be noted on each line item

[P or B]: indicate P for Satin Pewter, B for Satin Bronze

Note: W indicates wood transaction shelf.

A indicates acrylic solid surface transaction shelf. Specify Alabaster White or Ebony Skies on order.

Veneer species must be noted on each line item

Veneer Grade 1    Veneer Grade 2    Veneer Grade 3

Cherry                      Rift Oak                      Anigre  
Maple                      Sapele  
Ligno-Grain  
Walnut

# HBF LOGICwork

## Reception Desks, Returns

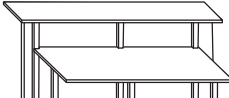
Style Number	List Price			Worksurface Length	Dimensions			Weight	
	Veneer 1	Veneer 2	Veneer 3		OW	OD	OH		
	LG81E[P or B]W-LHL	5020	5412	5999	69 3/4	81 3/4	35 3/4	42	230
	LG81F[P or B]W-LHL	5325	5741	6364	75 3/4	87 3/4	35 3/4	42	245
	LG81G[P or B]W-LHL	5940	6404	7099	81 3/4	93 3/4	35 3/4	42	260
	LG81H[P or B]W-LHL	6250	6738	7469	87 3/4	99 3/4	35 3/4	42	275

Veneer species must be noted on each line item

[P or B]: indicate P for Satin Pewter, B for Satin Bronze

Note: W indicates wood transaction shelf.

	LG81E[P or B]A-LHL	6250	6738	7469	69 3/4	81 3/4	35 3/4	42	260
	LG81F[P or B]A-LHL	6555	7067	7834	75 3/4	87 3/4	35 3/4	42	275
	LG81G[P or B]A-LHL	7170	7730	8569	81 3/4	93 3/4	35 3/4	42	295
	LG81H[P or B]A-LHL	7480	8064	8939	87 3/4	99 3/4	35 3/4	42	305

Veneer species must be noted on each line item

[P or B]: indicate P for Satin Pewter, B for Satin Bronze

Note: A indicates acrylic solid surface transaction shelf. Specify Alabaster White or Ebony Skies on order.

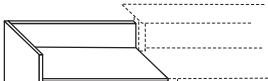
	LG85R-HK/KH	1840	1984	2199		37 1/8	30	35	105
	LG85S-HK/KH	2150	2318	2569		43 1/8	30	35	125
	LG85A-HK/KH	2455	2647	2934		49 1/8	30	35	145

Veneer species must be noted on each line item

Note: HK indicates right-hand, KH indicates left-hand.

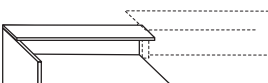
	LG86R-HK/KH	2150	2318	2569		37 1/8	30	36	125
	LG86S-HK/KH	2455	2647	2934		43 1/8	30	36	145
	LG86A-HK/KH	2765	2981	3304		49 1/8	30	36	165

Veneer species must be noted on each line item

Note: HK indicates right-hand, KH indicates left-hand.

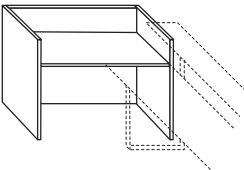
	LG83P-KHK	2250	2426	2689		32 1/4	24	35	135
	LG83R-KHK	2305	2485	2754		38 1/4	24	35	155
	LG83S-KHK	2355	2539	2814		44 1/4	24	35	175
	LG83A-KHK	2405	2593	2874		50 1/4	24	35	195
	LG83B-KHK	2455	2647	2934		56 1/4	24	35	215
	LG83C-KHK	2510	2706	2999		62 1/4	24	35	235
	LG83D-KHK	2560	2760	3059		68 1/4	24	35	255
	LG83E-KHK	2610	2814	3119		74 1/4	24	35	275
	LG83F-KHK	2660	2868	3179		80 1/4	24	35	295
	LG83G-KHK	2715	2927	3244		86 1/4	24	35	315
	LG83H-KHK	2765	2981	3304		92 1/4	24	35	335
	LG83J-KHK	2815	3035	3364		98 1/4	24	35	355
	LG83K-KHK	2865	3089	3424		104 1/4	24	35	375

Veneer species must be noted on each line item

Veneer species must be noted on each line item

Veneer Grade 1	Veneer Grade 2	Veneer Grade 3
Cherry	Rift Oak	Anigre
Maple	Sapele	
Ligno-Grain		
Walnut		

# HBF LOGICwork

## Reception Desks, Returns

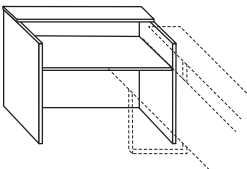
Style Number	List Price			Worksurface Length	Dimensions			Weight
	Veneer 1	Veneer 2	Veneer 3		OW	OD	OH	
<b>Reception Desks</b>								
	LG84P-KHK	2560	2760	3059	32 1/4	24	36	155
	LG84R-KHK	2610	2814	3119	38 1/4	24	36	175
	LG84S-KHK	2660	2868	3179	44 1/4	24	36	195
	LG84A-KHK	2715	2927	3244	50 1/4	24	36	215
	LG84B-KHK	2765	2981	3304	56 1/4	24	36	235
	LG84C-KHK	2815	3035	3364	62 1/4	24	36	255
	LG84D-KHK	2865	3089	3424	68 1/4	24	36	275
	LG84E-KHK	2920	3148	3489	74 1/4	24	36	295
	LG84F-KHK	2970	3202	3549	80 1/4	24	36	315
	LG84G-KHK	3020	3256	3609	86 1/4	24	36	335
	LG84H-KHK	3070	3310	3669	92 1/4	24	36	355
	LG84J-KHK	3125	3369	3734	98 1/4	24	36	375
	LG84K-KHK	3175	3423	3794	104 1/4	24	36	395

Veneer species must be noted on each line item

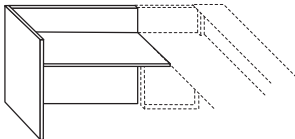
	LG83P-HK/KH	1740	1876	2079	31 1/8	24	35	95
	LG83R-HK/KH	1790	1930	2139	37 1/8	24	35	115
	LG83S-HK/KH	1840	1984	2199	43 1/8	24	35	135
	LG83A-HK/KH	1895	2043	2264	49 1/8	24	35	155
	LG83B-HK/KH	1945	2097	2324	55 1/8	24	35	175
	LG83C-HK/KH	1995	2151	2384	61 1/8	24	35	195
	LG83D-HK/KH	2045	2205	2444	67 1/8	24	35	215
	LG83E-HK/KH	2100	2264	2509	73 1/8	24	35	235
	LG83F-HK/KH	2150	2318	2569	79 1/8	24	35	255
	LG83G-HK/KH	2200	2372	2629	85 1/8	24	35	275
	LG83H-HK/KH	2250	2426	2689	91 1/8	24	35	295
	LG83J-HK/KH	2305	2485	2754	97 1/8	24	35	315
	LG83K-HK/KH	2355	2539	2814	103 1/8	24	35	335

Veneer species must be noted on each line item

Note: HK indicates right-hand, KH indicates left-hand.

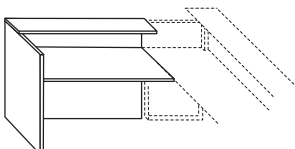
	LG84P-HK/KH	2045	2205	2444	31 1/8	24	36	115
	LG84R-HK/KH	2100	2264	2509	37 1/8	24	36	135
	LG84S-HK/KH	2150	2318	2569	43 1/8	24	36	155
	LG84A-HK/KH	2200	2372	2629	49 1/8	24	36	175
	LG84B-HK/KH	2250	2426	2689	55 1/8	24	36	195
	LG84C-HK/KH	2305	2485	2754	61 1/8	24	36	215
	LG84D-HK/KH	2355	2539	2814	67 1/8	24	36	235
	LG84E-HK/KH	2405	2593	2874	73 1/8	24	36	255
	LG84F-HK/KH	2455	2647	2934	79 1/8	24	36	275
	LG84G-HK/KH	2510	2706	2999	85 1/8	24	36	295
	LG84H-HK/KH	2560	2760	3059	91 1/8	24	36	315
	LG84J-HK/KH	2610	2814	3119	97 1/8	24	36	335
	LG84K-HK/KH	2660	2868	3179	103 1/8	24	36	355

Veneer species must be noted on each line item

Note: HK indicates right-hand, KH indicates left-hand.

### Veneer species must be noted on each line item

Veneer Grade 1	Veneer Grade 2	Veneer Grade 3
Cherry	Rift Oak	Anigre
Maple	Sapele	
Ligno-Grain		
Walnut		

# HBF LOGICwork Accessories

Style Number	List Price	Dimensions			Weight
		OW	OD	OH	

## Garage Mount Monitor Arm

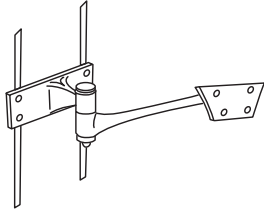

AC[P or B]98F	140			
---------------	-----	--	--	--

[P or B]: indicate P for Satin Pewter, B for Satin Bronze

Note: Monitor arm is supplied with necessary hardware for installation on vertical support of garage. Garage mount monitor arm must be used between two garage vertical supports, and is intended for use only with LOGICwork Garage systems.

## Power Center with Grommet

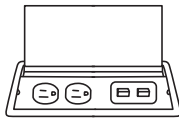

AC[P or B]96M	250	7	10 3/4	
---------------	-----	---	--------	--

[P or B]: indicate P for Satin Pewter, B for Satin Bronze

This power/data unit provides two (2) 110 volt electrical outlets and two data jacks. The unit uses a soft cord with grounded plug.

## Curved Accessory Tray Set

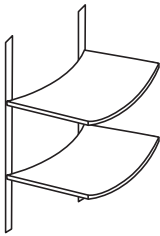

AC[P or B]98H	250	10	10 3/4	
---------------	-----	----	--------	--

Includes mounting hardware for connection to garage vertical and two shelves, intended for use only with the LOGICwork garage system.

AC[P or B]98J	90	10	10 3/4	
---------------	----	----	--------	--

Additional curved shelf for AC [P or B] 98Hs

[P or B]: indicate P for Satin Pewter, B for Satin Bronze

## Accessory Trays

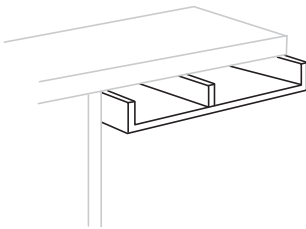

	No. of Compartments		OW	OD	OH	
AC[P or B]96J-18	1	215	18	13 1/2	2 3/4	15
AC[P or B]96J-30	2	235	30	13 1/2	2 3/4	25
AC[P or B]96J-36	3	255	36	13 1/2	2 3/4	30

Includes hardware for attaching to underside of horizontal beam or worksurface.

[P or B]: indicate P for Satin Pewter, B for Satin Bronze

## Paper Tray

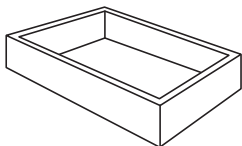

AC[P or B]96K	75	10 1/4	12 1/4	1 3/4
---------------	----	--------	--------	-------

Note: Paper trays may be placed on worksurface, pedestal tops, and in LOGICwork accessory trays.

[P or B]: indicate P for Satin Pewter, B for Satin Bronze