

L O G I C W O R K



H B F

HBF 2009 Price List Contents

Effective Date: September 10, 2009

Mailing Address:
HBF/HBF Textiles
PO Box 8
Hickory, NC 28603-0008

Shipping Address:
HBF/HBF Textiles
900-12th Street Drive NW
Hickory, NC 28601-4763

Phone: 828.328.2064
Fax: 828.328.8816
info: info@hbf.com
www.hbf.com
www.hbftextiles.com

CONTENTS

	PAGE
SPECIFICATIONS: LOGICwork	
Access Panels, Removable.....	3
Doors.....	3
Drawers	3
Edge Details.....	3
Finish Availability Chart	2
FSC Certification.....	2
Garage Structure	6
Garage Worksurfaces.....	8
Grommets.....	4
Hardware	3
Levelers.....	3
Locks	4
Melamine.....	3
Modesty Panels	3
Pedestals.....	3
Specification Process	5
Suspension	3
Veneer Options.....	2
Worksurfaces.....	3
COMPONENTS	
Accessories	
Accessory Trays	41
Monitor Arm	41
Paper Tray	41
Power/Data Unit.....	41
Bookcases.....	31
Bridges.....	12
Cladding-Garage, Credenza, Return	16
Credenzas, Freestanding.....	36
Desk Extensions.....	10
Desks, Freestanding	32
File Pedestal, Mobile.....	12
Garage Components	15
Garage Structure	6
Garage Worksurfaces.....	8
Overhead Cabinets	17
Pantry Unit.....	27, 30
Reception Desk Returns	39
Reception Desks	38
Return Removable Access Panel	14
Returns	13
Table Desks.....	34
Vertical Storage, Double High	28
Vertical Storage, Single High	25
Wardrobe Unit.....	26, 27, 29

HBF LOGICwork Casegood Specifications

**All HBF casegood orders must be accompanied by suite layout drawings.
Drawings are needed to confirm proper unit configuration.
If drawings are not included, orders may be delayed to confirm specifications.**

Veneer

The following slip matched, plain sliced veneers are available with the finish options as shown below. Pricing for these veneers are shown by veneer grade.

Anigre: Color and grain variations are typical characteristics of anigre veneer. Color may range from light yellow to pale brown, sometimes with a pink tint. The grain pattern of anigre will also vary in frequency and size; grain pattern changes should be expected within a given product or suite of furniture.

FSC Certification

HBF has been granted Forest Stewardship Council (FSC) Chain-of-Custody Certification (SW-COC-003305) by the SmartWood program of the Rainforest Alliance. This new certification agreement will allow HBF to offer FSC certified wood veneer or core on a project basis to maintain Chain-of-Custody for the design firm and client. FSC Chain-of-Custody certification tracks certified wood from the forest to final production to ensure that responsible forestry practices were maintained at every level and to preserve this natural resource for generations to come. Contact HBF Customer Relations for pricing and lead time information.

Finish Availability Chart

		Cherry	Veneer Grade 1 Maple	Ligno-Grain	Walnut	Veneer Grade 2 Rift Oak	Sapele	Veneer Grade 3 Anigre
01	Centennial	•		•				
02	Espresso	•		•				
03	Imperial	•		•				
05	Tuscan	•		•				
06	Amber	•		•			•	
07	Chestnut	•		•				
09	Onyx	•		•				
10	Honey	•		•				
11	Amazon	•		•				
12	Wheat		•	•				
16	Caramel		•	•		•		
17	Scone						•	
18	Biscotti		M*					
19	Butterscotch							•
20	Hazelnut		M*					
21	Chai							•
22	Cider		M*					
23	Mocha					•		
24	Chocolat		M*					
25	Cocoa				•			
26	Latte		M*					
27	Honeycomb				•			
28	Nectar		M*					
29	Nutmeg				•			
30	Toffee		M*					

M* (maple): These finishes are available only on maple seating and occasional table products and allow the specifier to create a finish that is complementary to non-maple veneers available on conference and casegood products. HBF's maple seating and occasional table products can therefore be specified with HBF conference and casegoods constructed with the available non-maple veneers and create an office environment with complementary wood tones. These finishes are not available on conference or casegood products.

18 Biscotti on maple complements 17 Scone on sapele
 20 Hazelnut on maple complements 19 Butterscotch on anigre
 22 Cider on maple complements 21 Chai on anigre
 24 Chocolat on maple complements 23 Mocha on rift oak
 26 Latte on maple complements 25 Cocoa on walnut
 28 Nectar on maple complements 27 Honeycomb on walnut
 30 Toffee on maple complements 29 Nutmeg on walnut

All conference and casegood products are standard with a 30° sheen.

An upcharge of **10% Net** per unit for conference and casegood products, with a minimum upcharge of **\$500 Net** per order will apply for any custom wood finish.

HBF LOGICwork Casegood Specifications

Profile Edge Details

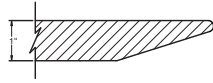

Worksurfaces

LOGICwork components have a 1" (25mm) thick worksurface premium grade veneer top faces. Edges are bordered with solids or edgebands.

Melamine

Melamine material is used on various LOGICwork components and is standard in two colors. Nubian Brown was selected to closely match the Satin Bronze metal finish, Fog Grey matches the Satin Pewter finish. The appropriate melamine color will be selected by HBF based on specification of finish for metal components.

Pedestals

Two depths for desks and garages/credenzas/returns.

Doors

Three (3) ply veneer doors are mounted with universal adjustment concealed hinges.

Levelers

All floor casegoods have adjustable levelers.

Modesty Panels

Desks modesty panels are available as finished, fixed panels that overlay the pedestal. Credenza, return back panels and bridge modesty panels are available as finished, fixed panels or as recessed, unfinished back removable access panels.

Drawers in Wood Pedestals

Box and file drawers are 1/2" wood, doweled to form a four (4) sided rectangle with separate drawer front. Drawer bottoms are 1/4" thick and fitted in a dado groove so it is captured on four sides. Drawer faces are mechanically attached to allow for easy alignment. Each desk equipped with a box/box/file pedestal will include one maple divider and one maple pencil tray. Center drawers are optional and include a cherry or maple pencil and paper clip tray, see HBF Casegood Accessories. Center drawers are standard on all LOGICwork table desks.

Suspension in Wood Pedestals

All box drawers are standard with telescopic, full extension, ball-bearing slides. All file drawers are standard with fully progressive, full extension, ball-bearing slides.

Removable Access Panels

LOGICwork garages, credenzas, returns or bridges without a finished back can be specified with removable access panels in the kneespace. This panel is positioned 4-1/2" from the back of the unit and can be easily removed to allow for complete wall access. When installed, the top of the access panel will be 2 5/8" from the underside of the worksurface to allow for wire or cable egress. The back of this panel and the back of pedestals are unfinished.

LOGICwork credenzas, returns or bridges specified with a finished back will be constructed with a fully finished, fixed modesty panel.

Pull Hardware Options

LOGICwork pulls are available in HBF Satin Nickel finish and are sized to fit appropriately on the door or drawer front.

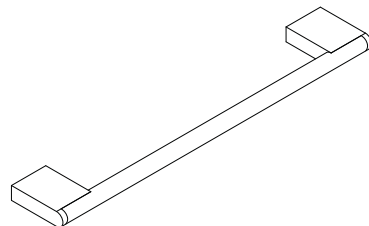

HBF LOGICwork Casegood Specifications

Locks

All wood case pedestals are standard with Satin Nickel face locks. All vertical storage cabinets, overhead cabinets and bookcases with doors are available with optional face locks. These locks will match the pedestal lock. **Add \$95 List** per lock for factory installation. (Locks standard on vertical cabinet file drawers)

Each individual unit (i.e. desk, credenza, overhead storage unit, etc.) will be keyed alike. If complete offices are required to be keyed alike, this designation must appear on each order. Units will be shipped with the lock barrels and locking mechanisms in place. A separate package will contain the appropriately numbered cylinders for field installations. If no specific lock instructions accompany the order, random keying between complete units will be installed.

Grommets

Grommets are optional on all LOGICwork desks, credenzas, returns, bridges, table desks, and desk extensions. **Add \$195 List** for each factory installed grommet. Grommet is available in HBF Satin Pewter and Satin Bronze powder coat finish.

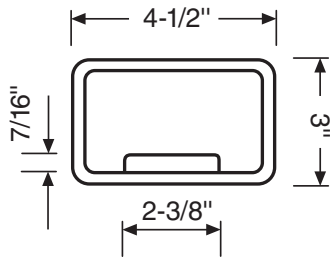

For added convenience, the drawings below should be used to define the placement of each optional grommet location. Please attach a copy to the order.

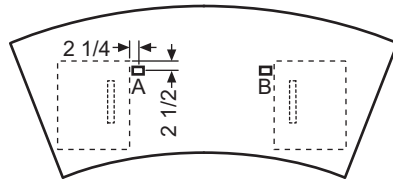

Desk - Arc Top

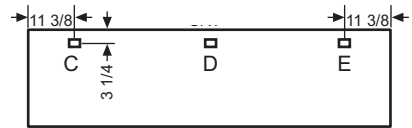

Credenza, Return, Bridge

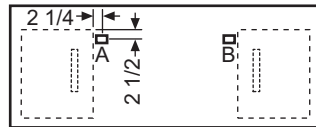

Desk - Rectangular Top

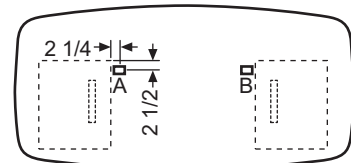

Desk - Arched Boat

If standard grommet placement locations do not provide suitable accessibility, a formal drawing of specified grommet location showing exact dimensions must accompany the order. No order specifying non-standard grommet placement will be entered until these drawings are received and approved by HBF.

HBF LOGICwork

Specification Process

LOGICwork components should be specified in the following order:

1. Garage Structure
2. Garage Worksurfaces
3. Desk Extensions, bridges and returns
4. Garage Components: Filing and storage, removable access panels, end supports, cladding, garage tackpanels
5. Overheads
6. Freestanding units: vertical storage units, bookcases, desks and credenzas
7. Accessories: paper management shelves and trays, power units and task lighting

The following price list pages provide ordering information and pricing for all LOGICwork components.

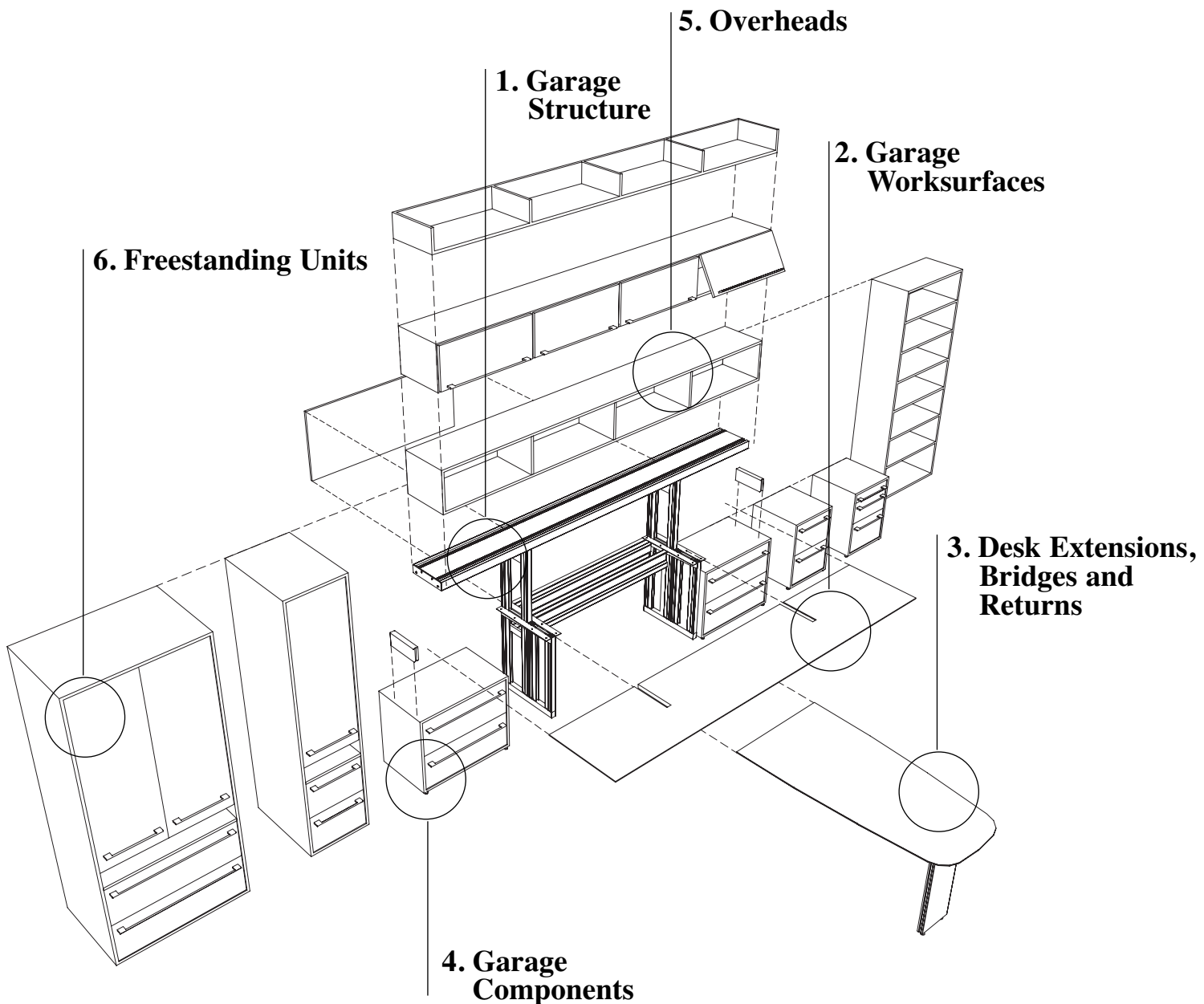

HBF LOGICwork

Garage Structure

The LOGICwork garage supports other LOGICwork components to create a variety of workwall configurations.

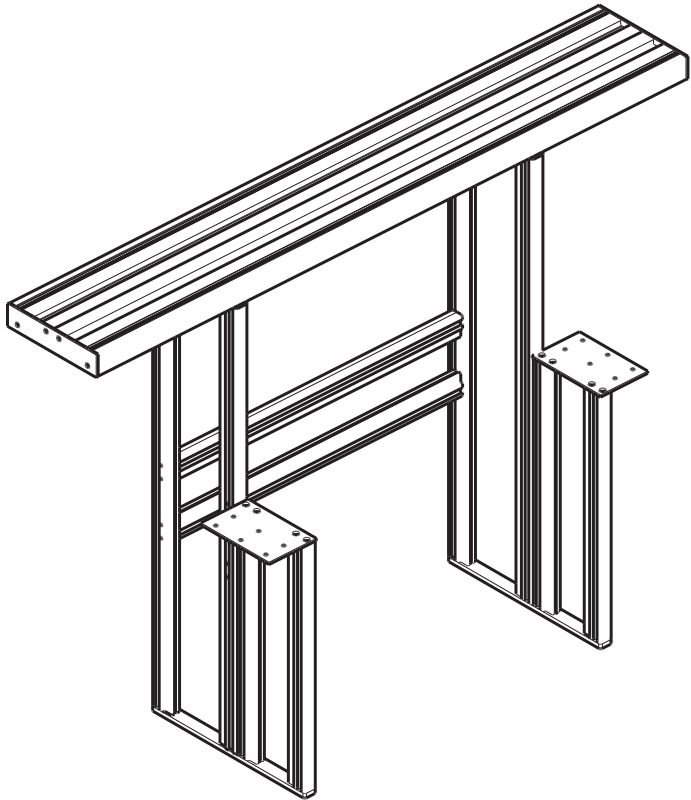

- Eight actual widths: 75", 81", 87", 93", 99", 105", 111", 117"
- Four overhang width dimensions: 0" (no overhang), 18", 30", 36"
- Maximum allowable distance or span between the two vertical supports is 84", minimum is 36"
- Each vertical support column is 1 1/2" wide, actual width of garage will be 3" wider than nominal width. Nominal width is used for garage specification purposes.
- The back of garages and all of its components are unfinished.
- Task lights may only be installed between the two vertical supports of the Garage Structure; refer to minimum opening under Task Lights to determine the style that can be accommodated between the vertical supports.

Diagrams below illustrate four overhang options for LOGICwork garages. Garage structures can be created in 87 different configurations by specifying different overall garage widths and different overhang widths. Included with diagrams are the appropriate style numbers for the examples. All configurations have an actual width of 87" and a nominal width of 84".

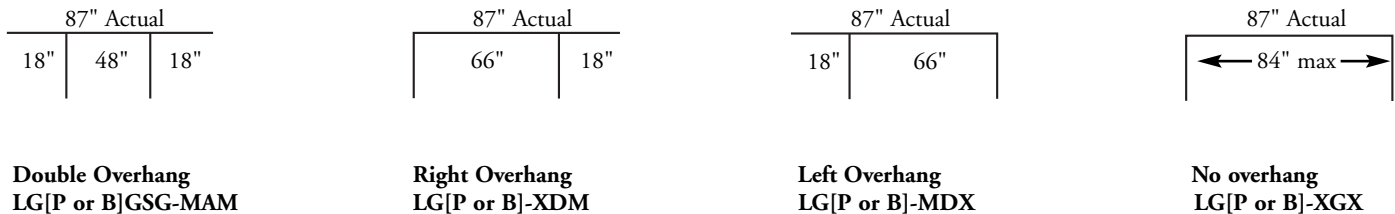

HBF LOGICwork

Garage Structure

L G P G S G - M A M

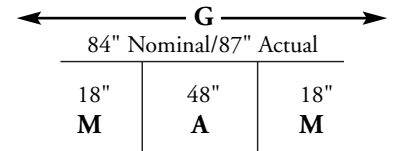
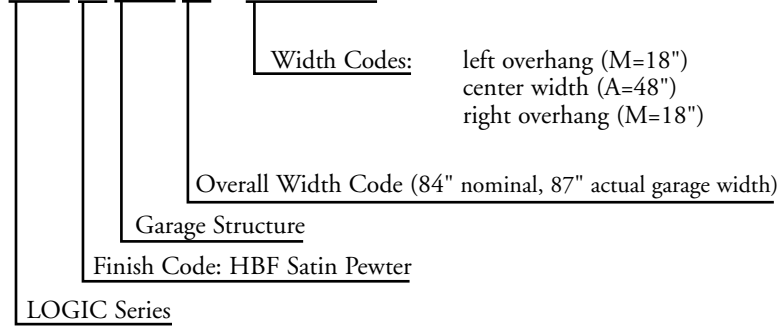

Finish Codes: P = Satin Pewter
B = Satin Bronze

Width Codes:	Width
Overall	
E	72" Nominal/75" Actual
F	78" Nominal/81" Actual
G	84" Nominal/87" Actual
H	90" Nominal/93" Actual
J	96" Nominal/99" Actual
K	102" Nominal/105" Actual
L	108" Nominal/111" Actual
T	114" Nominal/117" Actual

Width Codes:	Width
Overhangs, Center Width	
X	0"
M	18"
P	30"
R	36"
S	42"
A	48"
B	54"
C	60"
D	66"
E	72"
F	78"
G	84"

Style Number	List Price	Nominal Width	OD	Weight
LG[P or B]GSE-[www]	1150	75	25	73
LG[P or B]GSF-[www]	1185	78	25	76
LG[P or B]GSG-[www]	1220	84	25	82
LG[P or B]GSH-[www]	1255	90	25	87
LG[P or B]GSJ-[www]	1290	96	25	93
LG[P or B]GSK-[www]	1325	102	25	99
LG[P or B]GSL-[www]	1385	108	25	104
LG[P or B]GST-[www]	1465	114	25	110

[P or B]: indicate finish for metal support, P = Satin Pewter, B= Satin Bronze
[www]: indicate three width codes for left overhang, center width, and right overhang

HBF LOGICwork

Garage Worksurfaces

LOGICwork garage worksurfaces are attached to the garage structure and include two recesses/slots to accommodate the garage vertical supports.

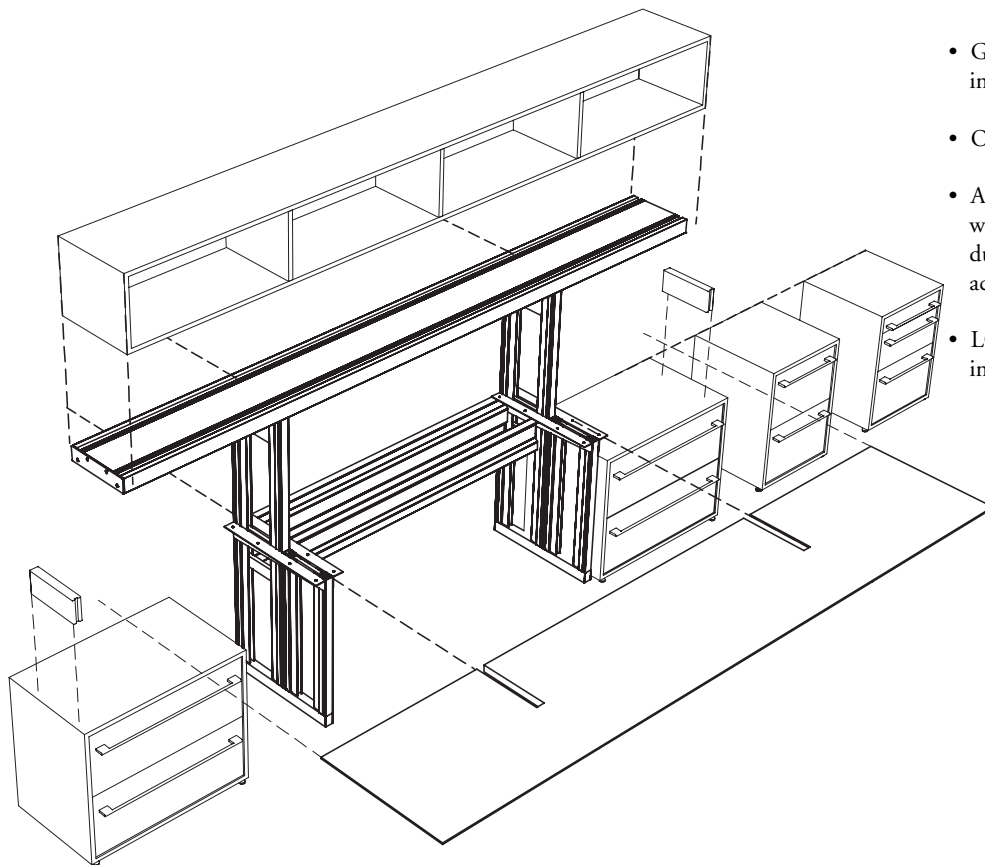

- Garage worksurfaces are available in 12 widths
- Overall depth is 25"
- Actual width of the garage worksurface will be 3" wider than nominal width due to the two 1 1/2" recesses that accommodate the garage vertical supports
- LOGICwork garage worksurfaces will include the appropriate standoffs.

HBF LOGICwork

Garage Worksurfaces

L G 3 5 G - M A M

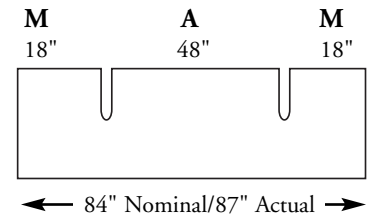
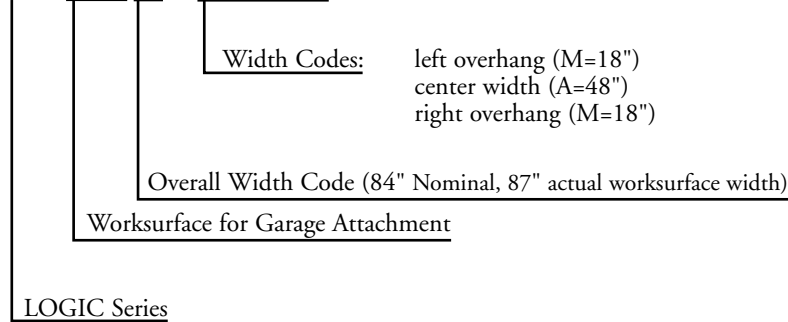

Veneer: Veneer species must be noted on each line item.

Width Codes:

Overall	Width
E	72" Nominal/75" Actual
F	78" Nominal/81" Actual
G	84" Nominal/87" Actual
H	90" Nominal/93" Actual
J	96" Nominal/99" Actual
K	102" Nominal/105" Actual
L	108" Nominal/111" Actual
T	114" Nominal/117" Actual
U	120" Nominal/123" Actual
V	126" Nominal/129" Actual
W	132" Nominal/135" Actual
X	138" Nominal/141" Actual

Width Codes:

Overhangs, Center Width	Width
X	0"
M	18"
P	30"
R	36"
S	42"
A	48"
B	54"
C	60"
D	66"
E	72"
F	78"
G	84"

Style Number	List Price			Nominal Width	OD	Weight
	Veneer 1	Veneer 2	Veneer 3			
LG35E-[www]	1095	1183	1314	72	25	70
LG35F-[www]	1245	1345	1494	78	25	75
LG35G-[www]	1295	1399	1554	84	25	80
LG35H-[www]	1345	1453	1614	90	25	85
LG35J-[www]	1395	1507	1674	96	25	90
LG35K-[www]	1445	1561	1734	102	25	96
LG35L-[www]	1465	1582	1758	108	25	102
LG35T-[www]	1565	1690	1878	114	25	108
LG35U-[www]	1585	1712	1902	120 (2 piece top)	25	116
LG35V-[www]	2335	2522	2802	126 (2 piece top)	25	126
LG35W-[www]	2385	2576	2862	132 (2 piece top)	25	136
LG35X-[www]	2435	2630	2922	138 (2 piece top)	25	146

Veneer species must be noted on each line item

[www]: indicate three width codes for left overhang, center width, and right overhang

HBF LOGICwork

Desk Extensions

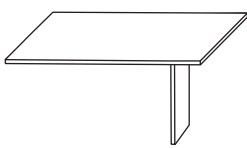
Style Number	List Price			Dimensions				
	Veneer 1	Veneer 2	Veneer 3	OW	OD	OH	Weight	
Desk Extensions, Rectangular								
	LG20A-[P or B]	1955	2111	2346	50 1/2	30	29	156
	LG20B-[P or B]	2055	2219	2466	50 1/2	36	29	175
	LG20C-[P or B]	1995	2155	2394	56 1/2	30	29	174
	LG20D-[P or B]	2105	2273	2526	56 1/2	36	29	196
	LG20E-[P or B]	2055	2219	2466	62 1/2	30	29	191
	LG20F-[P or B]	2155	2327	2586	62 1/2	36	29	226
	LG20G-[P or B]	2105	2273	2526	68 1/2	30	29	206
	LG20H-[P or B]	2205	2381	2646	68 1/2	36	29	254
	LG20J-[P or B]	2155	2327	2586	74 1/2	30	29	222
	LG20K-[P or B]	2255	2435	2706	74 1/2	36	29	281

Veneer species must be noted on each line item

[P or B]: indicate finish for metal support, P = Satin Pewter, B= Satin Bronze

Desk Extensions, Arched Boat

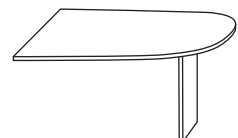
	LG25A-[P or B]	2355	2543	2826	50 1/2	30	29	156
	LG25B-[P or B]	2455	2651	2946	50 1/2	36	29	175
	LG25C-[P or B]	2395	2587	2874	56 1/2	30	29	174
	LG25D-[P or B]	2505	2705	3066	56 1/2	36	29	196
	LG25E-[P or B]	2455	2651	2946	62 1/2	30	29	191
	LG25F-[P or B]	2555	2759	3066	62 1/2	36	29	226
	LG25G-[P or B]	2505	2705	3006	68 1/2	30	29	206
	LG25H-[P or B]	2605	2813	3126	68 1/2	36	29	254
	LG25J-[P or B]	2555	2759	3066	74 1/2	30	29	222
	LG25K-[P or B]	2655	2867	3186	74 1/2	36	29	281

Veneer species must be noted on each line item

[P or B]: indicate finish for metal support, P = Satin Pewter, B= Satin Bronze

Desk Extensions, Arc LH

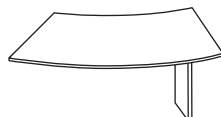
	LG26A-[P or B]	2305	2489	2766	48	30	29	156
	LG26B-[P or B]	2405	2597	2886	48	36	29	175
	LG26C-[P or B]	2345	2533	2814	54	30	29	174
	LG26D-[P or B]	2455	2651	2946	54	36	29	196
	LG26E-[P or B]	2405	2597	2886	60	30	29	191
	LG26F-[P or B]	2505	2705	3066	60	36	29	226
	LG26G-[P or B]	2455	2651	2946	66	30	29	206
	LG26H-[P or B]	2555	2759	3066	66	36	29	254
	LG26J-[P or B]	2505	2705	3006	72	30	29	222
	LG26K-[P or B]	2605	2813	3126	72	36	29	281

Veneer species must be noted on each line item

[P or B]: indicate finish for metal support, P = Satin Pewter, B= Satin Bronze

Veneer species must be noted on each line item

Veneer Grade 1	Veneer Grade 2	Veneer Grade 3
Cherry	Rift Oak	Anigre
Maple	Sapele	
Ligno-Grain		
Walnut		

HBF LOGICwork

Desk Extensions

Style Number	List Price			Dimensions			
	Veneer 1	Veneer 2	Veneer 3	OW	OD	OH	Weight
Desk Extensions, Arc RH							
LG27A-[P or B]	2305	2489	2766	48	30	29	156
LG27B-[P or B]	2405	2597	2886	48	36	29	175
LG27C-[P or B]	2345	2533	2814	54	30	29	174
LG27D-[P or B]	2455	2651	2946	54	36	29	196
LG27E-[P or B]	2405	2597	2886	60	30	29	191
LG27F-[P or B]	2505	2705	3006	60	36	29	226
LG27G-[P or B]	2455	2651	2946	66	30	29	206
LG27H-[P or B]	2555	2759	3066	66	36	29	254
LG27J-[P or B]	2505	2705	3006	72	30	29	222
LG27K-[P or B]	2605	2813	3126	72	36	29	281

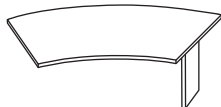

Veneer species must be noted on each line item

[P or B]: indicate finish for metal support, P = Satin Pewter, B= Satin Bronze

Desk Extensions, Rectangular with Modesty

LG20A-[P or B]M	2455	2651	2946	48	30	29	156
LG20B-[P or B]M	2555	2759	3066	48	36	29	175
LG20C-[P or B]M	2495	2695	2994	54	30	29	174
LG20D-[P or B]M	2605	2813	3126	54	36	29	196
LG20E-[P or B]M	2555	2759	3066	60	30	29	191
LG20F-[P or B]M	2655	2867	3186	60	36	29	226
LG20G-[P or B]M	2605	2813	3126	66	30	29	206
LG20H-[P or B]M	2705	2921	3246	66	36	29	254
LG20J-[P or B]M	2655	2867	3186	72	30	29	222
LG20K-[P or B]M	2755	2975	3306	72	36	29	281

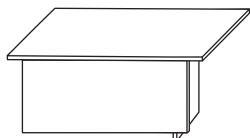

Veneer species must be noted on each line item

[P or B]: indicate finish for metal support, P = Satin Pewter, B= Satin Bronze

Desk Extensions, Arched Boat with Modesty

LG25A-[P or B]M	2855	3083	3426	48	30	29	156
LG25B-[P or B]M	2955	3191	3546	48	36	29	175
LG25C-[P or B]M	2895	3127	3474	54	30	29	174
LG25D-[P or B]M	3005	3245	3606	54	36	29	196
LG25E-[P or B]M	2955	3191	3546	60	30	29	191
LG25F-[P or B]M	3055	3299	3666	60	36	29	226
LG25G-[P or B]M	3005	3245	3606	66	30	29	206
LG25H-[P or B]M	3105	3353	3726	66	36	29	254
LG25J-[P or B]M	3055	3299	3666	72	30	29	222
LG 25K-[P or B]M	3155	3407	3786	72	36	29	281

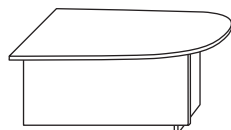

Veneer species must be noted on each line item

[P or B]: indicate finish for metal support, P = Satin Pewter, B= Satin Bronze

Veneer species must be noted on each line item

Veneer Grade 1	Veneer Grade 2	Veneer Grade 3
Cherry	Rift Oak	Anigre
Maple	Sapele	
Ligno-Grain		
Walnut		

HBF LOGICwork Bridges

Style Number	List Price			Dimensions			
	Veneer 1	Veneer 2	Veneer 3	OW	OD	OH	Weight

Mobile Pedestal

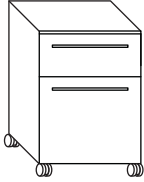

LG30	1695	1831	2034	18	21	25 1/2	135
-------------	-------------	-------------	-------------	----	----	--------	-----

Veneer species must be noted on each line item

Note: Casters, one box drawer and one file drawer with lock. Pedestal will nest under any 29" overhead worksurface.

Bridges

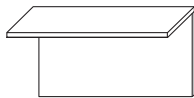

LG52A	1265	1366	1518	42	25	29	147
LG52B	1315	1420	1578	48	25	29	159
LG52C	1665	1798	1998	54	25	29	171

Veneer species must be noted on each line item

Finished, fixed modesty panel.

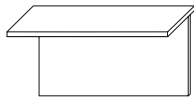

LG51A	1070	1156	1284	42	25	29	137
LG51B	1110	1199	1332	48	25	29	149
LG51C	1380	1490	1656	54	25	29	161

Veneer species must be noted on each line item

Removable access panel; wood front, standard black, unfinished back.

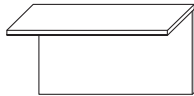

LG51A-[P or B]	970	1048	1164	42	25	29	137
LG51B-[P or B]	1010	1091	1212	48	25	29	149
LG51C-[P or B]	1280	1382	1536	54	25	29	161

Veneer species must be noted on each line item

[P or B]: indicate finish for melamine back, P = Satin Pewter, B= Satin Bronze

Removable access panel; melamine front, standard black, unfinished back.

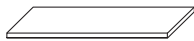

LG50A	645	697	774	42	25		104
LG50B	685	1064	1182	48	25		116
LG50C	955	1031	1146	54	25		128

Veneer species must be noted on each line item

Bridge top only.



LG35CT	495	535	594	24 1/2	12 1/4		25
---------------	------------	------------	------------	--------	--------	--	----

Veneer species must be noted on each line item

Corner bridge top only, to be mounted between two rectangular worksurfaces connected at a 90 degree angle. Mounting hardware included. Front edge of corner top has the LOGICwork edge detail, flat on two back edges.

Veneer species must be noted on each line item

<u>Veneer Grade 1</u>	<u>Veneer Grade 2</u>	<u>Veneer Grade 3</u>
Cherry	Rift Oak	Anigre
Maple	Sapele	
Ligno-Grain		
Walnut		

HBF LOGICwork

Returns

- LOGICwork returns attach to garage worksurfaces, freestanding credenzas or single pedestal desks
- Returns are specified by components; worksurface top, removable access panels, end panels and filing/storage units
- Tops are available in 22 different widths
- Pedestals are available in wood or metal with three different drawer front options

Return Worksurface

Style Numbers:	Description
LG41 (w)	A return worksurface with an edge detail on the user side
LG42 (w)	A return worksurface with edge details on the user side and the unattached end
LG43 (w)	A return worksurface with edge details on the user and visitor sides and the unattached end, this top includes a fixed finished modesty panel

Veneer: Veneer species must be noted on each line item

Width Codes (w):	Nominal Width	OD	List Price Style Numbers 41, 42			List Price Style Number 43			Weight
			Veneer 1	Veneer 2	Veneer 3	Veneer 1	Veneer 2	Veneer 3	
M	18	25	395	427	474	1015	1096	1218	33
N	24	25	435	470	522	1065	1150	1278	37
P	30	25	545	589	654	1165	1258	1398	41
R	36	25	585	632	702	1215	1312	1458	45
S	42	25	645	697	774	1265	1366	1518	49
A	48	25	685	740	822	1315	1420	1578	53
B	54	25	955	1031	1146	1665	1798	1998	57
C	60	25	995	1075	1194	1665	1798	1998	61
D	66	25	1045	1129	1254	1775	1917	2130	65
E	72	25	1095	1183	1314	1805	1949	2166	70
F	78	25	1245	1345	1494	2155	2327	2586	75
G	84	25	1295	1399	1554	2205	2381	2646	80
H	90	25	1345	1453	1614	2365	2554	2838	85
J	96	25	1395	1507	1674	2415	2608	2898	90
K	102	25	1445	1561	1734	2645	2857	3174	96
L	108	25	1465	1582	1758	2685	2900	3222	102
T	114	25	1565	1690	1878	2835	3062	3402	108
U	120	25	1585	1712	1902 (2 piece top)	2865	3094	3438 (2 piece top)	116
V	126	25	2335	2522	2802 (2 piece top)	3615	3904	4338 (2 piece top)	126
W	132	25	2385	2576	2862 (2 piece top)	3665	3958	4398 (2 piece top)	136
X	138	25	2435	2630	2922 (2 piece top)	3715	4012	4458 (2 piece top)	146

Style Number Descriptions

Product Code: Denotes the product as a return and also specifies the number of return finished sides.

41 - 1 Side: Front finished. Return back is unfinished.

42 - 2 Sides: Front and one end finished. Return back is unfinished.

43 - 3 Sides: Front, back and one end finished.



Finished - 1 Side (41)
Nominal Width = Actual Width
Actual Depth = 25"
Standard Black Unfinished Back



Finished - 2 Sides (42)
Nominal Width + 2 1/2" = Actual Width
Actual Depth = 25"
Standard Black Unfinished Back



Finished - 3 Sides (43)
Nominal Width + 2 1/2" = Actual Width
Actual Depth = 25"
Finished Back

HBF LOGICwork

Returns, Removable Access Panels, End Panels

Style Number	Description	List Price			Dimensions				
		Veneer 1	Veneer 2	Veneer 3	OW	OD	OH	Weight	
Return Pedestals, Wood Cases with Wood Drawer Face									
LG30A	Box/Box/File	1485	1604	1782	18	20	25 1/2	125	
LG30B	File/File	1485	1604	1782	18	20	25 1/2	125	
LG30C	Lateral File	1790	1933	2148	30	20	25 1/2	140	
LG30D	Lateral File	1895	2047	2274	36	20	25 1/2	140	
LG30U	Single Door Cabinet	1210	1307	1452	18	20	25 1/2	95	
LG30E	Double Door Cabinet	1515	1636	1818	30	20	25 1/2	95	
LG30F	Double Door Cabinet	1545	1669	1854	36	20	25 1/2	105	

Veneer species must be noted on each line item

Removable Access Panel with Wood Face									
LG30G1	365	394	438	6"-30"	24				
LG30G2	425	459	510	31"-60"	42				
LG30G3	785	848	942	61"-90"	60				
LG30G4	1065	1150	1278	91"-138"	60				

Veneer species must be noted on each line item

Removable Access Panel with Melamine Face									
LG[P or B]30G1	265	N/A	N/A	6"-30"	24				
LG[P or B]30G2	325	N/A	N/A	31"-60"	42				
LG[P or B]30G3	685	N/A	N/A	61"-90"	60				
LG[P or B]30G4	965	N/A	N/A	91"-138"	60				

[P or B]: indicate P for Satin Pewter, B for Satin Bronze

End Panels									
LG[P or B]30K (with veneer panel)	670	724	804	N/A	45				

[P or B]: indicate P for Satin Pewter, B for Satin Bronze

Veneer species must be noted on each line item

LG[P or B]30L	465	N/A	N/A	N/A	22				
---------------	-----	-----	-----	-----	----	--	--	--	--

[P or B]: indicate P for Satin Pewter, B for Satin Bronze

Veneer species must be noted on each line item

Veneer Grade 1	Veneer Grade 2	Veneer Grade 3
Cherry	Rift Oak	Anigre
Maple	Sapele	
Ligno-Grain		
Walnut		

HBF LOGICwork

Garage Components

Filing and Storage Units



Box/Box/File
18" OW

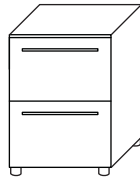

File/File
18" OW

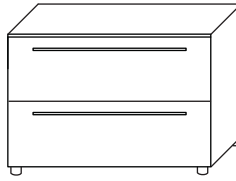

Lateral File
30" and 36" OW

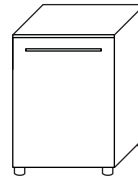

Single Door Cabinet
18" OW

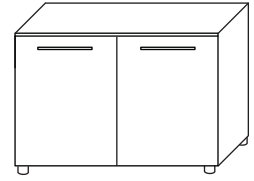

Double Door Cabinet
30" and 36" OH

- Specify metal foot color

Style Number	Description	List Price			Dimensions			
		Veneer 1	Veneer 2	Veneer 3	OW	OD	OH	Weight
Garage Pedestals, Wood Cases with Wood Drawer Fronts								
LG 30A	Box/Box/File	1485	1604	1782	18	20	25 1/2	125
LG 30B	File/File	1485	1604	1782	18	20	25 1/2	125
LG 30C	Lateral File	1790	1933	2148	30	20	25 1/2	140
LG 30D	Lateral File	1895	2047	2274	36	20	25 1/2	140
LG 30UL	Single Door Cabinet, Hinged Left	1210	1307	1452	18	20	25 1/2	95
LG 30UR	Single Door Cabinet, Hinged Right	1210	1307	1452	18	20	25 1/2	95
LG 30E	Double Door Cabinet	1515	1636	1818	30	20	25 1/2	105
LG 30F	Double Door Cabinet	1545	1669	1854	36	20	25 1/2	110

Veneer species must be noted on each line item

Removable Access Panel with Wood Face

LG30G1	365	394	438	6"-30"	24
LG30G2	425	459	510	31"-60"	42
LG30G3	785	848	942	61"-90"	60

Veneer species must be noted on each line item

Removable Access Panel with Melamine Face

LG[P or B]30G1	265	N/A	N/A	6"-30"	24
LG[P or B]30G2	325	N/A	N/A	31"-60"	42
LG[P or B]30G3	685	N/A	N/A	61"-90"	60

[P or B]: indicate P for Satin Pewter Melamine, B for Satin Bronze Melamine

End Panels with Veneer Panel

LG[P or B]30K	670	724	804	N/A	45
---------------	-----	-----	-----	-----	----

[P or B]: indicate P for Satin Pewter, B for Satin Bronze

Veneer species must be noted on each line item

LG[P or B]30L	465	N/A	N/A	N/A	22
---------------	-----	-----	-----	-----	----

[P or B]: indicate P for Satin Pewter, B for Satin Bronze

Garage Tackpanels

	Fabric				
LG F30T1	3 yards	215	N/A	N/A	18"-30" Nominal Width 15
LG F30T2	3 yards	290	N/A	N/A	31"-60" Nominal Width 25
LG F30T3	3 yards	345	N/A	N/A	61"-84" Nominal Width 35

Veneer species must be noted on each line item

Veneer Grade 1	Veneer Grade 2	Veneer Grade 3
Cherry	Rift Oak	Anigre
Maple	Sapele	
Ligno-Grain		
Walnut		

HBF LOGICwork

Garage, Credenza, Return, or Desk Cladding

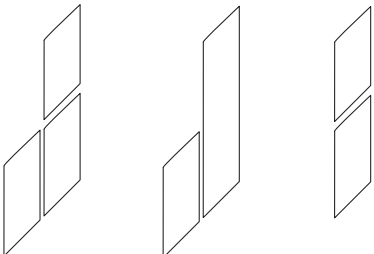
	Style Number	Description	List Price		
			Veneer 1	Veneer 2	Veneer 3
Garage Vertical Support Cladding, Metal					
	LG[P or B]GC-FC	Full Center	100	N/A	N/A
	LG[P or B]GC-FE	Full End	100	N/A	N/A
	LG[P or B]GC-HC	Half Center	65	N/A	N/A

Full Center Full End Half Center

[P or B]: indicate P for Satin Pewter, B for Satin Bronze

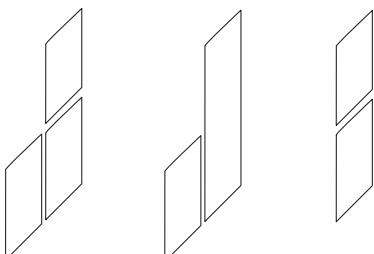
Garage Vertical Support Cladding, Wood					
	LG[P or B]GC-FC-V	Full Center	200	216	240
	LG[P or B]GC-FE-V	Full End	200	216	240
	LG[P or B]GC-HC-V	Half Center	130	140	156

Full Center Full End Half Center

Veneer species must be noted on each line item

[P or B]: indicate P for Satin Pewter, B for Satin Bronze

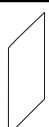
Garage, Credenza, or Return Recessed End Cladding, Metal					
	LG[P or B]REC		95	N/A	N/A

[P or B]: indicate P for Satin Pewter, B for Satin Bronze

Garage, Credenza, or Return Recessed End Cladding, Wood					
	LG[P or B]REC-V		255	140	156

Veneer species must be noted on each line item

[P or B]: indicate P for Satin Pewter, B for Satin Bronze

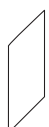
Desk Recessed End Cladding, Metal					
	LG[P or B]RDC		95	N/A	N/A

[P or B]: indicate P for Satin Pewter, B for Satin Bronze

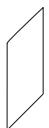
Desk Recessed End Cladding, Wood					
	LG[P or B]RDC-V		255	140	156



Veneer species must be noted on each line item

[P or B]: indicate P for Satin Pewter, B for Satin Bronze

Veneer species must be noted on each line item

Veneer Grade 1	Veneer Grade 2	Veneer Grade 3
Cherry	Rift Oak	Anigre
Maple	Sapele	
Ligno-Grain		
Walnut		

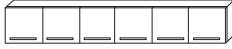

HBF LOGICwork Overhead Cabinets

Style Number	Fabric	List Price			Number of Doors	Dimensions			Weight	
		Veneer 1	Veneer 2	Veneer 3		OW	OD	OH		
Overhead Cabinets, Garage Mount with Hinged Wood Doors and Melamine Back										
	LG64M-A[P or B]		2305	2489	2766	4	75	14 5/8	14 1/2	195
	LG64N-A[P or B]		2825	3051	3390	6	81	14 5/8	14 1/2	215
	LG64P-A[P or B]		3015	3256	3618	6	87	14 5/8	14 1/2	215
	LG64R-A[P or B]		3195	3451	3834	6	93	14 5/8	14 1/2	225
	LG64S-A[P or B]		3395	3667	4074	6	99	14 5/8	14 1/2	225
	LG64T-A[P or B]		3475	3753	4170	6	105	14 5/8	14 1/2	235
	LG64U-A[P or B]		3765	4066	4518	8(2 piece unit)	111	14 5/8	14 1/2	235
	LG64V-A[P or B]		3925	4239	4710	8(2 piece unit)	117	14 5/8	14 1/2	245

Veneer species must be noted on each line item

[P or B]: indicate P for Satin Pewter/Fog Grey, B for Satin Bronze/Nubian Brown

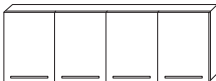
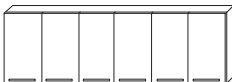

Overhead Cabinets, Garage Mount with Hinged Wood Doors and Melamine Back (Double High)

	LG64M-A[P or B]2		3385	3656	4062	4	75	14 5/8	28 1/4	220
	LG64N-A[P or B]2		3935	4250	4722	6	81	14 5/8	28 1/4	240
	LG64P-A[P or B]2		4145	4477	4974	6	87	14 5/8	28 1/4	240
	LG64R-A[P or B]2		4335	4682	5202	6	93	14 5/8	28 1/4	250
	LG64S-A[P or B]2		4535	4898	5442	6	99	14 5/8	28 1/4	250
	LG64T-A[P or B]2		4735	5114	5682	6	105	14 5/8	28 1/4	260
	LG64U-A[P or B]2		4935	5330	5922	8(2 piece unit)	111	14 5/8	28 1/4	260
	LG64V-A[P or B]2		5135	5546	6162	8(2 piece unit)	117	14 5/8	28 1/4	270

Veneer species must be noted on each line item

[P or B]: indicate P for Satin Pewter/Fog Grey, B for Satin Bronze/Nubian Brown

Overhead Cabinets, Garage Mount with Half High Hinged Wood Doors and Wood Back (Double High)

	LG64M-C2		3285	3548	3942	4	75	14 5/8	28 1/4	215
	LG64N-C2		3835	4142	4602	6	81	14 5/8	28 1/4	235
	LG64P-C2		4045	4369	4854	6	87	14 5/8	28 1/4	235
	LG64R-C2		4235	4574	5082	6	93	14 5/8	28 1/4	245
	LG64S-C2		4435	4790	5322	6	99	14 5/8	28 1/4	245
	LG64T-C2		4635	5006	5562	6	105	14 5/8	28 1/4	255
	LG64U-C2		4835	5222	5802	8(2 piece unit)	111	14 5/8	28 1/4	255
	LG64V-C2		5035	5438	6042	8(2 piece unit)	117	14 5/8	28 1/4	265

Veneer species must be noted on each line item

Due to the depth of door hardware, end doors on LOGICwork overhead units are hinged to open inward in order to prevent damage to adjacent vertical storage units or wall.

Veneer species must be noted on each line item

Veneer Grade 1	Veneer Grade 2	Veneer Grade 3
Cherry	Rift Oak	Anigre
Maple	Sapele	
Ligno-Grain		
Walnut		

HBF LOGICwork Overhead Cabinets

Style Number	Fabric	List Price			Number of Doors	Dimensions			Weight	
		Veneer 1	Veneer 2	Veneer 3		OW	OD	OH		
Overhead Cabinets, Garage Mount with Half High Hinged Wood Doors and Melamine Back (Double High)										
	LG64M-C[P or B]2		3035	3278	3642	4	75	14 5/8	28 1/4	215
	LG64N-C[P or B]2		3585	3872	4302	6	81	14 5/8	28 1/4	235
	LG64P-C[P or B]2		3795	4099	4554	6	87	14 5/8	28 1/4	235
	LG64R-C[P or B]2		3985	4304	4782	6	93	14 5/8	28 1/4	245
	LG64S-C[P or B]2		4185	4520	5022	6	99	14 5/8	28 1/4	245
	LG64T-C[P or B]2		4385	4736	5262	6	105	14 5/8	28 1/4	255
	LG64U-C[P or B]2		4585	4952	5502	8 (2 piece unit)	111	14 5/8	28 1/4	255
	LG64V-C[P or B]2		4785	5168	5742	8 (2 piece unit)	117	14 5/8	28 1/4	265
Veneer species must be noted on each line item [P or B]: indicate P for Satin Pewter/Fog Grey, B for Satin Bronze/Nubian Brown										

Overhead Cabinets, Garage Mount with Wood Flipper Doors and Melamine Back										
	LG64M-B[P or B]		2305	2489	2766	2	75	14 5/8	14 1/2	195
	LG64N-B[P or B]		2825	3051	3390	3	81	14 5/8	14 1/2	215
	LG64P-B[P or B]		3015	3256	3618	3	87	14 5/8	14 1/2	215
	LG64R-B[P or B]		3195	3451	3834	3	93	14 5/8	14 1/2	225
	LG64S-B[P or B]		3395	3667	4074	3	99	14 5/8	14 1/2	225
	LG64T-B[P or B]		3475	3753	4170	3	105	14 5/8	14 1/2	235
	LG64U-B[P or B]		3765	4066	4518	4 (2 piece unit)	111	14 5/8	14 1/2	235
	LG64V-B[P or B]		3925	4239	4710	4 (2 piece unit)	117	14 5/8	14 1/2	245
Veneer species must be noted on each line item [P or B]: indicate P for Satin Pewter/Fog Grey, B for Satin Bronze/Nubian Brown										

Overhead Cabinets, Garage Mount with Half High Wood Flipper Doors and Wood Back (Double High)										
	LG64M-D2		3285	3548	3942	2	75	14 5/8	28 1/4	215
	LG64N-D2		3835	4142	4602	3	81	14 5/8	28 1/4	235
	LG64P-D2		4045	4369	4854	3	87	14 5/8	28 1/4	235
	LG64R-D2		4235	4574	5082	3	93	14 5/8	28 1/4	245
	LG64S-D2		4435	4790	5322	3	99	14 5/8	28 1/4	245
	LG64T-D2		4635	5006	5562	3	105	14 5/8	28 1/4	255
	LG64U-D2		4835	5222	5802	4 (2 piece unit)	111	14 5/8	28 1/4	255
	LG64V-D2		5035	5438	6042	4 (2 piece unit)	117	14 5/8	28 1/4	265
Veneer species must be noted on each line item										

Due to the depth of door hardware, end doors on LOGICwork overhead units are hinged to open inward in order to prevent damage to adjacent vertical storage units or wall.

Veneer species must be noted on each line item



Veneer Grade 1	Veneer Grade 2	Veneer Grade 3
Cherry	Rift Oak	Anigre
Maple	Sapele	
Ligno-Grain		
Walnut		

HBF LOGICwork

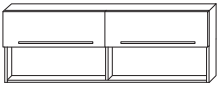
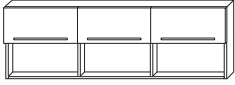
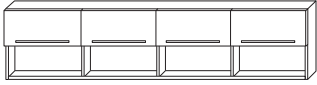

Overhead Cabinets

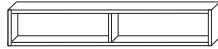
Style Number	Fabric	List Price			Number of Doors	Dimensions			Weight
		Veneer 1	Veneer 2	Veneer 3		OW	OD	OH	
Overhead Cabinets, Garage Mount with Half High Wood Flipper Doors and Melamine Back (Double High)									
	LG64M-D[P or B]2	3035	3278	3642	2	75	14 5/8	28 1/4	215
	LG64N-D[P or B]2	3585	3872	4302	3	81	14 5/8	28 1/4	235
	LG64P-D[P or B]2	3795	4099	4554	3	87	14 5/8	28 1/4	235
	LG64R-D[P or B]2	3985	4304	4782	3	93	14 5/8	28 1/4	245
	LG64S-D[P or B]2	4185	4520	5022	3	99	14 5/8	28 1/4	245
	LG64T-D[P or B]2	4385	4736	5262	3	105	14 5/8	28 1/4	255
	LG64U-D[P or B]2	4585	4952	5502	4 (2 piece unit)	111	14 5/8	28 1/4	255
	LG64V-D[P or B]2	4785	5168	5742	4 (2 piece unit)	117	14 5/8	28 1/4	265
Veneer species must be noted on each line item									
[P or B]: indicate P for Satin Pewter/Fog Grey, B for Satin Bronze/Nubian Brown									

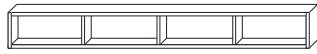
Overhead Cabinets, Garage Mount Open with Melamine Back

	LG64M-E[P or B]	1605	1733	1926	2	75	13 3/4	14 1/2	175
	LG64N-E[P or B]	2125	2295	2550	3	81	13 3/4	14 1/2	195
	LG64P-E[P or B]	2315	2500	2778	3	87	13 3/4	14 1/2	195
	LG64R-E[P or B]	2495	2695	2994	3	93	13 3/4	14 1/2	205
	LG64S-E[P or B]	2695	2911	3234	3	99	13 3/4	14 1/2	205
	LG64T-E[P or B]	2775	2997	3330	3	105	13 3/4	14 1/2	215
	LG64U-E[P or B]	3065	3310	3678	4 (2 piece unit)	111	13 3/4	14 1/2	215
	LG64V-E[P or B]	3225	3483	3870	4 (2 piece unit)	117	13 3/4	14 1/2	225
Veneer species must be noted on each line item									
[P or B]: indicate P for Satin Pewter/Fog Grey, B for Satin Bronze/Nubian Brown									

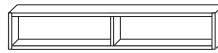
Overhead Cabinets, Garage Mount Open with Wood Back

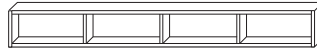
	LG64M-E	1855	2003	2226		75	13 3/4	14 1/2	175
	LG64N-E	2375	2565	2850		81	13 3/4	14 1/2	195
	LG64P-E	2565	2770	3078		87	13 3/4	14 1/2	195
	LG64R-E	2745	2965	3294		93	13 3/4	14 1/2	205
	LG64S-E	2945	3181	3534		99	13 3/4	14 1/2	205
	LG64T-E	3025	3267	3630		105	13 3/4	14 1/2	215
	LG64U-E	3315	3580	3978	(2 piece unit)	111	13 3/4	14 1/2	215
	LG64V-E	3475	3753	4170	(2 piece unit)	117	13 3/4	14 1/2	225
Veneer species must be noted on each line item									

Due to the depth of door hardware, end doors on LOGICwork overhead units are hinged to open inward in order to prevent damage to adjacent vertical storage units or wall.



Veneer species must be noted on each line item

Veneer Grade 1	Veneer Grade 2	Veneer Grade 3
Cherry	Rift Oak	Anigre
Maple	Sapele	
Ligno-Grain		
Walnut		

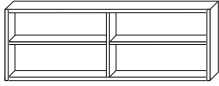
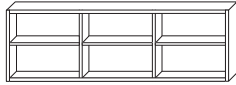
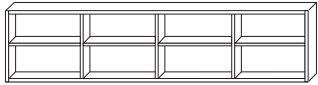
HBF LOGICwork Overhead Cabinets

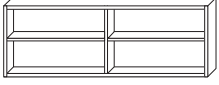
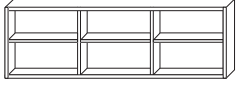
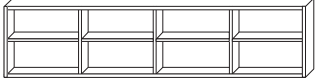
Style Number	Fabric	List Price			Number of Doors	Dimensions			Weight	
		Veneer 1	Veneer 2	Veneer 3		OW	OD	OH		
Overhead Cabinets, Garage Mount Open with Melamine Back (Double High)										
	LG64M-E[P or B]2		2335	2522	2802		75	13 3/4	28 1/4	195
	LG64N-E[P or B]2		2885	3116	3462		81	13 3/4	28 1/4	215
	LG64P-E[P or B]2		3095	3343	3714		87	13 3/4	28 1/4	215
	LG64R-E[P or B]2		3285	3548	3942		93	13 3/4	28 1/4	225
	LG64S-E[P or B]2		3485	3764	4182		99	13 3/4	28 1/4	225
	LG64T-E[P or B]2		3685	3980	4422		105	13 3/4	28 1/4	235
	LG64U-E[P or B]2		3885	4196	4662	(2 piece unit)	111	13 3/4	28 1/4	235
	LG64V-E[P or B]2		4085	4412	4902	(2 piece unit)	117	13 3/4	28 1/4	245
Veneer species must be noted on each line item [P or B]: indicate P for Satin Pewter/Fog Grey, B for Satin Bronze/Nubian Brown										

Overhead Cabinets, Garage Mount Open with Wood Back (Double High)										
	LG64M-E2		2585	2792	3102		75	13 3/4	28 1/4	195
	LG64N-E2		3135	3386	3762		81	13 3/4	28 1/4	215
	LG64P-E2		3345	3613	4014		87	13 3/4	28 1/4	215
	LG64R-E2		3535	3818	4242		93	13 3/4	28 1/4	225
	LG64S-E2		3735	4034	4482		99	13 3/4	28 1/4	225
	LG64T-E2		3935	4250	4722		105	13 3/4	28 1/4	235
	LG64U-E2		4135	4466	4962	(2 piece unit)	111	13 3/4	28 1/4	235
	LG64V-E2		4335	4682	5202	(2 piece unit)	117	13 3/4	28 1/4	245
Veneer species must be noted on each line item										



Overhead Shelves, Garage Mount Half High Open with Wood Back										
	LG64M-F		785	848	942		75	13 3/4	6	125
	LG64N-F		885	956	1062		81	13 3/4	6	145
	LG64P-F		975	1053	1170		87	13 3/4	6	145
	LG64R-F		1085	1172	1302		93	13 3/4	6	155
	LG64S-F		1195	1291	1434		99	13 3/4	6	155
	LG64T-F		1295	1399	1554		105	13 3/4	6	165
	LG64U-F		1425	1539	1710	(2 piece unit)	111	13 3/4	6	165
	LG64V-F		1595	1723	1914	(2 piece unit)	117	13 3/4	6	175
Veneer species must be noted on each line item										

Due to the depth of door hardware, end doors on LOGICwork overhead units are hinged to open inward in order to prevent damage to adjacent vertical storage units or wall.

Veneer species must be noted on each line item

Veneer Grade 1	Veneer Grade 2	Veneer Grade 3
Cherry	Rift Oak	Anigre
Maple	Sapele	
Ligno-Grain		
Walnut		

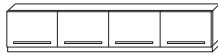
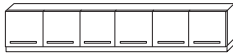
HBF LOGICwork Overhead Cabinets



Style Number	Fabric	List Price			Number of Doors	Dimensions			Weight	
		Veneer 1	Veneer 2	Veneer 3		OW	OD	OH		
Overhead Cabinets, Wall Mount with Hinged Wood Doors and Melamine Back										
	LG65M-A[P or B]	2-1/2 yds.	3155	3407	3786	4	72	15 1/2	16 3/8	195
	LG65N-A[P or B]	3 yds.	3675	3969	4410	6	78	15 1/2	16 3/8	215
	LG65P-A[P or B]	3 yds.	3865	4174	4638	6	84	15 1/2	16 3/8	215
	LG65R-A[P or B]	3 yds.	4045	4369	4854	6	90	15 1/2	16 3/8	225
	LG65S-A[P or B]	3-1/4 yds.	4245	4585	5094	6	96	15 1/2	16 3/8	225
	LG65T-A[P or B]	3-1/2 yds.	4325	4671	5190	6	102	15 1/2	16 3/8	235
	LG65U-A[P or B]	3-3/4 yds.	4615	4984	5538	8 (2 piece unit)	108	15 1/2	16 3/8	235
	LG65V-A[P or B]	4-1/4 yds.	4775	5157	5730	8 (2 piece unit)	114	15 1/2	16 3/8	245

Veneer species must be noted on each line item

[P or B]: indicate P for Satin Pewter/Fog Grey, B for Satin Bronze/Nubian Brown

Note: Wall mount overheads include a wall mount tackpanel.

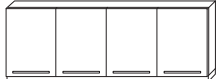
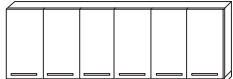
Overhead Cabinets, Wall Mount with Hinged Wood Doors and Melamine Back (Double High)



	LG65M-A[P or B]2	2-1/2 yds.	4235	4574	5082	4	72	15 1/2	30 1/8	220
	LG65N-A[P or B]2	3 yds.	4785	5168	5742	6	78	15 1/2	30 1/8	240
	LG65P-A[P or B]2	3 yds.	4995	5395	5994	6	84	15 1/2	30 1/8	240
	LG65R-A[P or B]2	3 yds.	5185	5600	6222	6	90	15 1/2	30 1/8	250
	LG65S-A[P or B]2	3-1/4 yds.	5385	5816	6462	6	96	15 1/2	30 1/8	250
	LG65T-A[P or B]2	3-1/2 yds.	5585	6032	6702	6	102	15 1/2	30 1/8	260
	LG65U-A[P or B]2	3-3/4 yds.	5785	6248	6942	8 (2 piece unit)	108	15 1/2	30 1/8	260
	LG65V-A[P or B]2	4-1/4 yds.	5985	6464	7182	8 (2 piece unit)	114	15 1/2	30 1/8	270

Veneer species must be noted on each line item

[P or B]: indicate P for Satin Pewter/Fog Grey, B for Satin Bronze/Nubian Brown

Note: Wall mount overheads include a wall mount tackpanel.

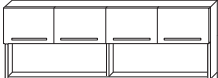
Overhead Cabinets, Wall Mount with Half High Hinged Wood Doors and Wood Back (Double High)

	LG65M-C2	2-1/2 yds.	4135	4466	4962	4	72	15 1/2	30 1/8	215
	LG65N-C2	3 yds.	4685	5060	5622	6	78	15 1/2	30 1/8	235
	LG65P-C2	3 yds.	4895	5287	5874	6	84	15 1/2	30 1/8	235
	LG65R-C2	3 yds.	5085	5492	6102	6	90	15 1/2	30 1/8	245
	LG65S-C2	3-1/4 yds.	5285	5708	6342	6	96	15 1/2	30 1/8	245
	LG65T-C2	3-1/2 yds.	5485	5924	6582	6	102	15 1/2	30 1/8	255
	LG65U-C2	3-3/4 yds.	5685	6140	6822	8 (2 piece unit)	108	15 1/2	30 1/8	255
	LG65V-C2	4-1/4 yds.	5885	6356	7062	8 (2 piece unit)	114	15 1/2	30 1/8	265

Veneer species must be noted on each line item

Note: Wall mount overheads include a wall mount tackpanel.



Single high and double high wall mounted overhead cabinets to be used with corresponding height wall mounted vertical cabinets. Proper installation of wall mounted overhead cabinets is the sole responsibility of the customer and is crucial to prevent personal injury.

Due to the depth of door hardware, end doors on LOGICwork overhead units are hinged to open inward in order to prevent damage to adjacent vertical storage units or wall.

Veneer species must be noted on each line item

Veneer Grade 1	Veneer Grade 2	Veneer Grade 3
Cherry	Rift Oak	Anigre
Maple	Sapele	
Ligno-Grain		
Walnut		

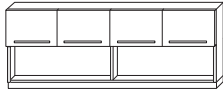
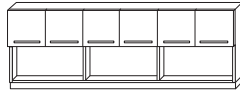
HBF LOGICwork Overhead Cabinets



Style Number	Fabric	List Price			Number of Doors	Dimensions			Weight	
		Veneer 1	Veneer 2	Veneer 3		OW	OD	OH		
Overhead Cabinets, Wall Mount with Half High Hinged Wood Doors and Melamine Back (Double High)										
	LG65M-C[P or B]2A	2-1/2 yds.	3885	4196	4662	4	72	15 1/2	30 1/8	215
	LG65N-C[P or B]2A	3 yds.	4435	4790	5322	6	78	15 1/2	30 1/8	235
	LG65P-C[P or B]2A	3 yds.	4645	5017	5574	6	84	15 1/2	30 1/8	235
	LG65R-C[P or B]2A	3 yds.	4835	5222	5802	6	90	15 1/2	30 1/8	245
	LG65S-C[P or B]2A	3-1/4 yds.	5035	5438	6042	6	96	15 1/2	30 1/8	245
	LG65T-C[P or B]2A	3-1/2 yds.	5235	5654	6282	6	102	15 1/2	30 1/8	255
	LG65U-C[P or B]2A	3-3/4 yds.	5435	5870	6522	8 (2 piece unit)	108	15 1/2	30 1/8	255
	LG65V-C[P or B]2A	4-1/4 yds.	5635	6086	6762	8 (2 piece unit)	114	15 1/2	30 1/8	265

Veneer species must be noted on each line item

[P or B]: indicate P for Satin Pewter/Fog Grey, B for Satin Bronze/Nubian Brown

Note: Wall mount overheads include a wall mount tackpanel.

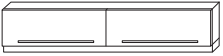
Overhead Cabinets, Wall Mount with Wood Flipper Doors and Melamine Back

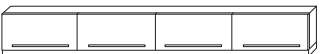

	LG65M-B[P or B]	2-1/2 yds.	3155	3407	3786	2	72	15 1/2	16 3/8	195
	LG65N-B[P or B]	3 yds.	3675	3969	4410	3	78	15 1/2	16 3/8	215
	LG65P-B[P or B]	3 yds.	3865	4174	4638	3	84	15 1/2	16 3/8	215
	LG65R-B[P or B]	3 yds.	4045	4369	4854	3	90	15 1/2	16 3/8	225
	LG65S-B[P or B]	3-1/4 yds.	4245	4585	5094	3	96	15 1/2	16 3/8	225
	LG65T-B[P or B]	3-1/2 yds.	4325	4671	5190	3	102	15 1/2	16 3/8	235
	LG65U-B[P or B]	3-3/4 yds.	4615	4984	5538	4 (2 piece unit)	108	15 1/2	16 3/8	235
	LG65V-B[P or B]	4-1/4 yds.	4775	5157	5730	4 (2 piece unit)	114	15 1/2	16 3/8	245

Veneer species must be noted on each line item

[P or B]: indicate P for Satin Pewter/Fog Grey, B for Satin Bronze/Nubian Brown

Note: Wall mount overheads include a wall mount tackpanel.

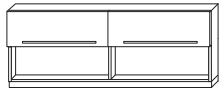
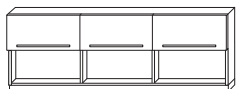
Overhead Cabinets, Wall Mount Half High with Wood Flipper Doors and Wood Back (Double High)

	LG65M-D2	2-1/2 yds.	4135	4466	4962	2	72	15 1/2	30 1/8	215
	LG65N-D2	3 yds.	4685	5060	5622	3	78	15 1/2	30 1/8	235
	LG65P-D2	3 yds.	4895	5287	5874	3	84	15 1/2	30 1/8	235
	LG65R-D2	3 yds.	5085	5492	6102	3	90	15 1/2	30 1/8	245
	LG65S-D2	3-1/4 yds.	5285	5708	6342	3	96	15 1/2	30 1/8	245
	LG65T-D2	3-1/2 yds.	5485	5924	6582	3	102	15 1/2	30 1/8	255
	LG65U-D2	3-3/4 yds.	5685	6140	6822	4 (2 piece unit)	108	15 1/2	30 1/8	255
	LG65V-D2	4-1/4 yds.	5885	6356	7062	4 (2 piece unit)	114	15 1/2	30 1/8	265

Veneer species must be noted on each line item

Note: Wall mount overheads include a wall mount tackpanel.

Single high and double high wall mounted overhead cabinets to be used with corresponding height wall mounted vertical cabinets. Proper installation of wall mounted overhead cabinets is the sole responsibility of the customer and is crucial to prevent personal injury.

Due to the depth of door hardware, end doors on LOGICwork overhead units are hinged to open inward in order to prevent damage to adjacent vertical storage units or wall.

Veneer species must be noted on each line item

Veneer Grade 1	Veneer Grade 2	Veneer Grade 3
Cherry	Rift Oak	Anigre
Maple	Sapele	
Ligno-Grain		
Walnut		

HBF LOGICwork Overhead Cabinets

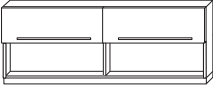
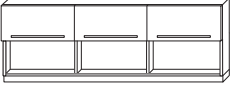
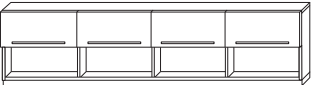
Style Number	Fabric	List Price			Number of Doors	Dimensions			Weight	
		Veneer 1	Veneer 2	Veneer 3		OW	OD	OH		
Overhead Cabinets, Wall Mount with Half High Wood Flipper Doors and Melamine Back (Double High)										
	LG65M-D[P or B]2	2-1/2 yds.	3885	4196	4662	2	72	15 1/2	30 1/8	215
	LG65N-D[P or B]2	3 yds.	4435	4790	5322	3	78	15 1/2	30 1/8	235
	LG65P-D[P or B]2	3 yds.	4645	5017	5574	3	84	15 1/2	30 1/8	235
	LG65R-D[P or B]2	3 yds.	4835	5222	5802	3	90	15 1/2	30 1/8	245
	LG65S-D[P or B]2	3-1/4 yds.	5035	5438	6042	3	96	15 1/2	30 1/8	245
	LG65T-D[P or B]2	3-1/2 yds.	5235	5654	6282	3	102	15 1/2	30 1/8	255
	LG65U-D[P or B]2	3-3/4 yds.	5435	5870	6522	4 (2 piece unit)	108	15 1/2	30 1/8	255
	LG65V-D[P or B]2	4-1/4 yds.	5635	6086	6762	4 (2 piece unit)	114	15 1/2	30 1/8	265

Veneer species must be noted on each line item

[P or B]: indicate P for Satin Pewter/Fog Grey, B for Satin Bronze/Nubian Brown

Note: Wall mount overheads include a wall mount tackpanel.

Overhead Cabinets, Wall Mount Open with Melamine Back

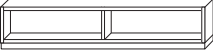
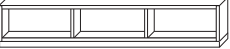
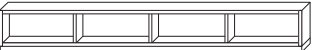
	LG65M-E[P or B]	2-1/2 yds.	2455	2651	2946	2	72	14 5/8	16 3/8	175
	LG65N-E[P or B]	3 yds.	2975	3213	3570	3	78	14 5/8	16 3/8	195
	LG65P-E[P or B]	3 yds.	3165	3418	3798	3	84	14 5/8	16 3/8	195
	LG65R-E[P or B]	3 yds.	3345	3613	4014	3	90	14 5/8	16 3/8	205
	LG65S-E[P or B]	3-1/4 yds.	3545	3829	4254	3	96	14 5/8	16 3/8	205
	LG65T-E[P or B]	3-1/2 yds.	3625	3915	4350	3	102	14 5/8	16 3/8	215
	LG65U-E[P or B]	3-3/4 yds.	3915	4228	4698	4 (2 piece unit)	108	14 5/8	16 3/8	215
	LG65V-E[P or B]	4-1/4 yds.	4075	4401	4890	4 (2 piece unit)	114	14 5/8	16 3/8	225

Veneer species must be noted on each line item

[P or B]: indicate P for Satin Pewter/Fog Grey, B for Satin Bronze/Nubian Brown

Note: Wall mount overheads include a wall mount tackpanel.

Overhead Cabinets, Wall Mount Open with Wood Back

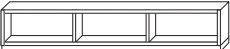
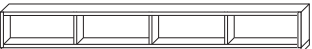
	LG65M-E	2-1/2 yds.	2705	2921	3246		72	14 5/8	16 3/8	175
	LG65N-E	3 yds.	3225	3483	3870		78	14 5/8	16 3/8	195
	LG65P-E	3 yds.	3415	3688	4098		84	14 5/8	16 3/8	195
	LG65R-E	3 yds.	3595	3883	4314		90	14 5/8	16 3/8	205
	LG65S-E	3-1/4 yds.	3795	4099	4554		96	14 5/8	16 3/8	205
	LG65T-E	3-1/2 yds.	3875	4185	4650		102	14 5/8	16 3/8	215
	LG65U-E	3-3/4 yds.	4165	4498	4998	(2 piece unit)	108	14 5/8	16 3/8	215
	LG65V-E	4-1/4 yds.	4325	4671	5190	(2 piece unit)	114	14 5/8	16 3/8	225

Veneer species must be noted on each line item

Note: Wall mount overheads include a wall mount tackpanel.

Single high and double high wall mounted overhead cabinets to be used with corresponding height wall mounted vertical cabinets. Proper installation of wall mounted overhead cabinets is the sole responsibility of the customer and is crucial to prevent personal injury.

Due to the depth of door hardware, end doors on LOGICwork overhead units are hinged to open inward in order to prevent damage to adjacent vertical storage units or wall.



Veneer species must be noted on each line item

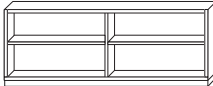
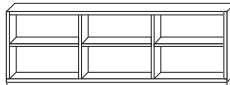
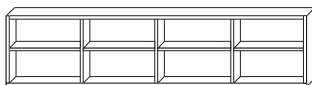

Veneer Grade 1	Veneer Grade 2	Veneer Grade 3
Cherry	Rift Oak	Anigre
Maple	Sapele	
Ligno-Grain		
Walnut		

HBF LOGICwork

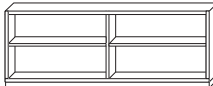
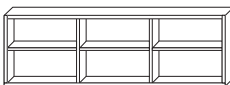
Overhead Cabinets

Style Number	Fabric	List Price			Number of Doors	Dimensions			Weight	
		Veneer 1	Veneer 2	Veneer 3		OW	OD	OH		
Overhead Cabinets, Wall Mount Open with Melamine Back (Double High)										
	LG65M-E[P or B]2	2-1/2 yds.	3185	3440	3822	72	14 5/8	30 1/8	195	
	LG65N-E[P or B]2	3 yds.	3735	4034	4482	78	14 5/8	30 1/8	215	
	LG65P-E[P or B]2	3 yds.	3945	4261	4734	84	14 5/8	30 1/8	215	
	LG65R-E[P or B]2	3 yds.	4135	4466	4962	90	14 5/8	30 1/8	225	
	LG65S-E[P or B]2	3-1/4 yds.	4335	4682	5202	96	14 5/8	30 1/8	225	
	LG65T-E[P or B]2	3-1/2 yds.	4535	4898	5442	102	14 5/8	30 1/8	235	
	LG65U-E[P or B]2	3-3/4 yds.	4735	5114	5682	(2 piece unit)	108	14 5/8	30 1/8	235
	LG65V-E[P or B]2	4-1/4 yds.	4935	5330	5922	(2 piece unit)	114	14 5/8	30 1/8	245
Veneer species must be noted on each line item										
[P or B]: indicate P for Satin Pewter/Fog Grey, B for Satin Bronze/Nubian Brown										
Note: Wall mount overheads include a wall mount tackpanel.										

Overhead Cabinets, Wall Mount Open with Wood Back (Double High)										
	LG65M-E2	2-1/2 yds.	3435	3710	4122	72	14 5/8	30 1/8	195	
	LG65N-E2	3 yds.	3985	4304	4782	78	14 5/8	30 1/8	215	
	LG65P-E2	3 yds.	4195	4531	5034	84	14 5/8	30 1/8	215	
	LG65R-E2	3 yds.	4385	4736	5262	90	14 5/8	30 1/8	225	
	LG65S-E2	3-1/4 yds.	4585	4952	5502	96	14 5/8	30 1/8	225	
	LG65T-E2	3-1/2 yds.	4785	5168	5742	102	14 5/8	30 1/8	235	
	LG65U-E2	3-3/4 yds.	4985	5384	5982	(2 piece unit)	108	14 5/8	30 1/8	235
	LG65V-E2	4-1/4 yds.	5185	5600	6222	(2 piece unit)	114	14 5/8	30 1/8	245
Veneer species must be noted on each line item										
Note: Wall mount overheads include a wall mount tackpanel.										

Overhead Shelves, Half High Open with Wood Back										
	LG65M-F		785	848	942	72	14 5/8	6	125	
	LG65N-F		885	956	1062	78	14 5/8	6	145	
	LG65P-F		975	1053	1170	84	14 5/8	6	145	
	LG65R-F		1085	1172	1302	90	14 5/8	6	155	
	LG65S-F		1195	1291	1434	96	14 5/8	6	155	
	LG65T-F		1295	1399	1554	102	14 5/8	6	165	
	LG65U-F		1425	1539	1710	(2 piece unit)	108	14 5/8	6	165
	LG65V-F		1595	1723	1914	(2 piece unit)	114	14 5/8	6	175
Veneer species must be noted on each line item										
Note: NOT a wall mounted unit. For use above a wall mount.										

Single high and double high wall mounted overhead cabinets to be used with corresponding height wall mounted vertical cabinets. Proper installation of wall mounted overhead cabinets is the sole responsibility of the customer and is crucial to prevent personal injury.

Due to the depth of door hardware, end doors on LOGICwork overhead units are hinged to open inward in order to prevent damage to adjacent vertical storage units or wall.

Veneer species must be noted on each line item

Veneer Grade 1	Veneer Grade 2	Veneer Grade 3
Cherry	Rift Oak	Anigre
Maple	Sapele	
Ligno-Grain		
Walnut		

HBF LOGICwork

Vertical Storage

Style Number	List Price			Dimensions			
	Veneer 1	Veneer 2	Veneer 3	OW	OD	OH	Weight

Vertical Storage Cabinets

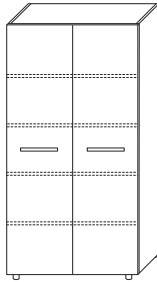

LG70M	3595	3883	4314	30	25 3/4	67	205
LG70N	3755	4055	4506	36	25 3/4	67	237

Veneer species must be noted on each line item

Storage unit, two doors, four adjustable shelves, cabinet back unfinished.

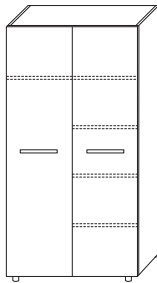

LG71M	3845	4153	4614	30	25 3/4	67	205
LG71N	3985	4304	4782	36	25 3/4	67	237

Veneer species must be noted on each line item

Storage/wardrobe unit, two doors, four adjustable shelves and a hat shelf with wardrobe rod, shelves are field changeable from left to right, cabinet back unfinished.

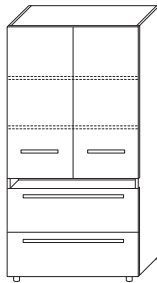

LG72M	4395	4747	5274	30	25 3/4	67	235
LG72N	4535	4898	5442	36	25 3/4	67	267

Veneer species must be noted on each line item

Storage unit, two doors and two adjustable shelves above and two locking lateral file drawers below. Cabinet back unfinished.

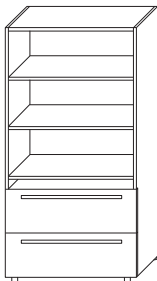

LG73M	4065	4390	4878	30	25 3/4	67	225
LG73N	4225	4563	5070	36	25 3/4	67	257

Veneer species must be noted on each line item

Storage unit, open above with two adjustable shelves, two locking lateral file drawers below. Cabinet back unfinished.

Veneer species must be noted on each line item

<u>Veneer Grade 1</u>	<u>Veneer Grade 2</u>	<u>Veneer Grade 3</u>
Cherry	Rift Oak	Anigre
Maple	Sapele	
Ligno-Grain		
Walnut		

HBF LOGICwork

Vertical Storage

Style Number		List Price			Dimensions			
		Veneer 1	Veneer 2	Veneer 3	OW	OD	OH	Weight

Vertical Storage Cabinets

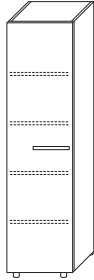

LGLH70P	(left hinge)	2975	3213	3570	18	25 3/4	67	176
LGRH70P	(right hinge)	2975	3213	3570	18	25 3/4	67	176

Veneer species must be noted on each line item

Storage unit, single door, four adjustable shelves. Cabinet back unfinished.

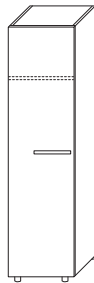

LGLH71P	(left hinge)	2755	2975	3306	18	25 3/4	67	166
LGRH71P	(right hinge)	2755	2975	3306	18	25 3/4	67	166

Veneer species must be noted on each line item

Wardrobe unit single door, hat shelf and wardrobe rod. Cabinet back unfinished.

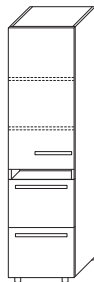

LGLH72P	(left hinge)	3645	3937	4374	18	25 3/4	67	196
LGRH72P	(right hinge)	3645	3937	4374	18	25 3/4	67	196

Veneer species must be noted on each line item

Storage unit, single door and two adjustable shelves above and two locking file drawers below. Cabinet back unfinished.

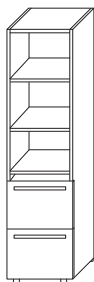

LG73P		3125	3375	3750	18	25 3/4	67	186
--------------	--	-------------	-------------	-------------	----	--------	----	-----

Veneer species must be noted on each line item

Storage unit, two open adjustable shelves above, two locking file drawers below. Cabinet back unfinished.

Veneer species must be noted on each line item

<u>Veneer Grade 1</u>	<u>Veneer Grade 2</u>	<u>Veneer Grade 3</u>
Cherry	Rift Oak	Anigre
Maple	Sapele	
Ligno-Grain		
Walnut		

HBF LOGICwork

Vertical Storage

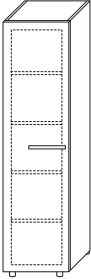
Style Number	List Price			Dimensions				
	Veneer 1	Veneer 2	Veneer 3	OW	OD	OH	Weight	
Vertical Storage Cabinets								
	LGLH74P (open on right)	3365	3634	4038	18	25 3/4	67	235
	LGRH74P (open on left)	3365	3634	4038	18	25 3/4	67	235

Veneer species must be noted on each line item

Pantry unit, pullout bookcase with four adjustable shelves. Cabinet back unfinished.

Note: Due to pullout function, pantry case must be attached to wall to ensure stability. Proper installation is the sole responsibility of the customer and is crucial to prevent personal injury.

Vertical Storage Cabinets (Double High)

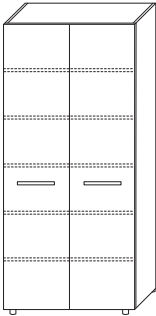
	LG70M2	4905	5297	5886	30	25 3/4	80 3/4	277
	LG70N2	5115	5524	6138	36	25 3/4	80 3/4	320

Veneer species must be noted on each line item

Storage unit, two doors, five adjustable shelves, cabinet back unfinished.

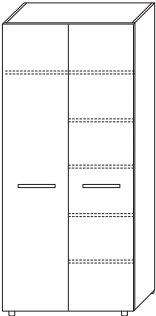
	LG71M2	5235	5645	6282	30	25 3/4	80 3/4	277
	LG71N2	5435	5870	6522	36	25 3/4	80 3/4	320

Veneer species must be noted on each line item

Storage/wardrobe unit, two doors, five adjustable shelves and a hat shelf with wardrobe rod, shelves are field changeable from left to right, cabinet back unfinished.

Veneer species must be noted on each line item

<u>Veneer Grade 1</u>	<u>Veneer Grade 2</u>	<u>Veneer Grade 3</u>
Cherry	Rift Oak	Anigre
Maple	Sapele	
Ligno-Grain		
Walnut		

HBF LOGICwork

Vertical Storage

Style Number	List Price			Dimensions			
	Veneer 1	Veneer 2	Veneer 3	OW	OD	OH	Weight

Vertical Storage Cabinets (Double High)

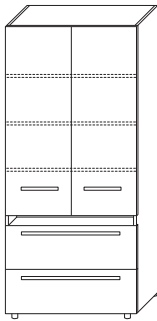

LG72M2	5995	6475	7194	30	25 3/4	80 3/4	307
LG72N2	6175	6669	7410	36	25 3/4	80 3/4	350

Veneer species must be noted on each line item

Storage unit, two doors and three adjustable shelves above, two locking lateral file drawers below. Cabinet back unfinished.

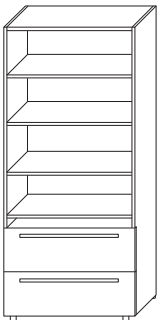

LG73M2	5535	5978	6642	30	25 3/4	80 3/4	297
LG73N2	5755	6215	6906	36	25 3/4	80 3/4	240

Veneer species must be noted on each line item

Storage unit, three open adjustable shelves above and two locking lateral file drawers below. Cabinet back unfinished.

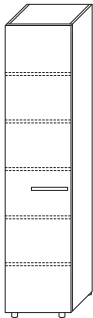

LGLH70P2	(left hinge)	4045	4369	4854	18	25 3/4	80 3/4	237
LGRH70P2	(right hinge)	4045	4369	4854	18	25 3/4	80 3/4	237

Veneer species must be noted on each line item

Storage unit, single door, five adjustable shelves. Cabinet back unfinished.

Veneer species must be noted on each line item

<u>Veneer Grade 1</u>	<u>Veneer Grade 2</u>	<u>Veneer Grade 3</u>
Cherry	Rift Oak	Anigre
Maple	Sapele	
Ligno-Grain		
Walnut		

HBF LOGICwork

Vertical Storage

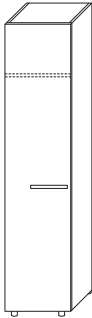
Style Number		List Price			Dimensions			
		Veneer 1	Veneer 2	Veneer 3	OW	OD	OH	Weight
	LGLH71P2 (left hinge)	3755	4055	4506	18	25 3/4	80 3/4	227
	LGRH71P2 (right hinge)	3755	4055	4506	18	25 3/4	80 3/4	227

Veneer species must be noted on each line item

Wardrobe unit, single door, hat shelf and wardrobe rod. Cabinet back unfinished.

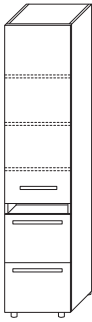
	LGLH72P2 (left hinge)	4965	5362	5958	18	25 3/4	80 3/4	267
	LGRH72P2 (right hinge)	4965	5362	5958	18	25 3/4	80 3/4	267

Veneer species must be noted on each line item

Storage unit, single door and three adjustable shelves above, two locking file drawers below. Cabinet back unfinished.

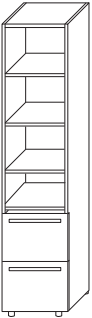
	LG73P2	4265	4606	5118	18	25 3/4	80 3/4	257
---	---------------	------	------	------	----	--------	--------	-----

Veneer species must be noted on each line item

Storage unit, three open adjustable shelves above and two locking file drawers below. Cabinet back unfinished.

Veneer species must be noted on each line item

<u>Veneer Grade 1</u>	<u>Veneer Grade 2</u>	<u>Veneer Grade 3</u>
Cherry	Rift Oak	Anigre
Maple	Sapele	
Ligno-Grain		
Walnut		

HBF LOGICwork

Vertical Storage

Style Number		List Price			Dimensions				
		Veneer 1	Veneer 2	Veneer 3	OW	OD	OH	Weight	
Vertical Storage Cabinets (Double High)									
LGLH74P2	(open on right)	4575	4941	5490	18	25 3/4	80 3/4	245	
LGRH74P2	(open on left)	4575	4941	5490	18	25 3/4	80 3/4	245	

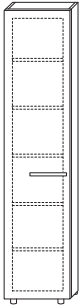

Veneer species must be noted on each line item

Pantry unit, pullout bookcase with five adjustable shelves. Flush top without profile edge detail, cabinet back unfinished.

Note: Due to pullout function, pantry case must be attached to wall to ensure stability. Proper installation is the sole responsibility of the customer and is crucial to prevent personal injury.

Veneer species must be noted on each line item

<u>Veneer Grade 1</u>	<u>Veneer Grade 2</u>	<u>Veneer Grade 3</u>
Cherry	Rift Oak	Anigre
Maple	Sapele	
Ligno-Grain		
Walnut		

HBF LOGICwork

Bookcases

Style Number	List Price			OW	Dimensions			Weight
	Veneer 1	Veneer 2	Veneer 3		OD	OH		

Bookcases

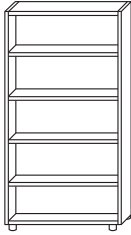

LG75MB	2825	3051	3390	30	13 3/4	67	195
LG75NB	2885	3116	3462	36	13 3/4	67	227

Veneer species must be noted on each line item

Four adjustable shelves, standard black unfinished back panel.

Note: Bookcases must be attached to wall to ensure stability. Proper installation is the sole responsibility of the customer and is crucial to prevent personal injury.

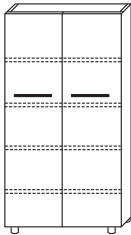

LG76MB	3045	3289	3654	30	14 5/8	67	205
LG76NB	3165	3418	3798	36	14 5/8	67	237

Veneer species must be noted on each line item

Two doors, four adjustable shelves, standard black unfinished back panel.

Note: Bookcases must be attached to wall to ensure stability. Proper installation is the sole responsibility of the customer and is crucial to prevent personal injury.

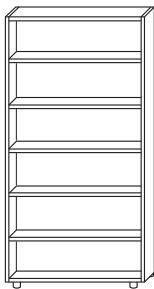

LG75MB2	3835	4142	4602	30	13 3/4	80 3/4	264
LG75NB2	3905	4217	4686	36	13 3/4	80 3/4	307

Veneer species must be noted on each line item

Five adjustable shelves, standard black unfinished back panel.

Note: Bookcases must be attached to wall to ensure stability. Proper installation is the sole responsibility of the customer and is crucial to prevent personal injury.

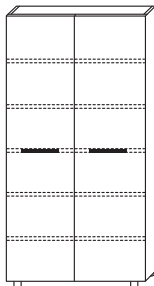

LG76MB2	4125	4455	4950	30	14 5/8	80 3/4	277
LG76NB2	4295	4639	5154	36	14 5/8	80 3/4	320

Veneer species must be noted on each line item

Two doors, five adjustable shelves, standard black unfinished back panel.

Note: Bookcases must be attached to wall to ensure stability. Proper installation is the sole responsibility of the customer and is crucial to prevent personal injury.

Veneer species must be noted on each line item

<u>Veneer Grade 1</u>	<u>Veneer Grade 2</u>	<u>Veneer Grade 3</u>
Cherry	Rift Oak	Anigre
Maple	Sapele	
Ligno-Grain		
Walnut		

HBF LOGICwork

Freestanding Desks

- LOGICwork desks are available in four top shapes
- Wood pedestals can be specified with wood or acrylic drawer fronts
- Metal pedestals can be specified with metal, wood or acrylic drawer fronts
- LOGICwork desks are specified by component: Desktops, pedestals, end panels and modesty panels

Desk Top Shapes



Rectangular

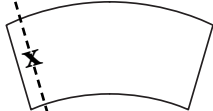

Arc (x = Worksurface Depth)

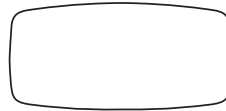

Arched Boat

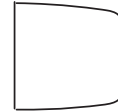

Half Arched Boat

Style Number	List Price			Dimensions			Worksurface Depth (x)	Weight
	Veneer 1	Veneer 2	Veneer 3	OW	OD	OH		
Rectangular Desk Top, Edge Profile 4 Sides								
LG01A	1520	1642	1824	70 3/4	30			85
LG01D	1620	1750	1944	76 3/4	30			95
LG01C	1620	1750	1944	70 3/4	36			95
LG01F	1720	1858	2064	76 3/4	36			105
LG01G	2110	2279	2532	82 3/4	36			110

Veneer species must be noted on each line item

Arc Desk Top, Edge Profile 4 sides

LG04A	2910	3143	3492	83 1/2	35 3/4		x = 30	90
LG04C	2990	3229	3588	87 1/2	41 3/4		x = 36	100
LG04D	2940	3175	3528	91	36 1/2		x = 30	110
LG04F	3020	3262	3624	95 1/2	42 1/2		x = 36	125

Veneer species must be noted on each line item

Arched Boat Desk Top, Edge Profile 4 Sides

LG06A	3285	3548	3942	88 3/4	34			90
LG06C	3365	3634	4038	94 3/4	34			100
LG06D	3315	3580	3978	88 3/4	40			110
LG06F	3395	3667	4074	94 3/4	40			125

Veneer species must be noted on each line item

Half Arched Boat Desk Top, Edge Profile 4 Sides

LG16J	3285	3548	3942	80	34			90
LG16K	3365	3634	4038	86	34			100
LG16L	3315	3580	3978	80	40			110
LG16M	3395	3667	4074	86	40			125

Veneer species must be noted on each line item

Rectangular Desk Top, Edge Profile 3 Sides

LG11A	1420	1534	1704	68 1/2	30			85
LG11D	1520	1642	1824	74 1/2	30			95
LG11C	1520	1642	1824	68 1/2	36			95
LG11F	1620	1750	1944	74 1/2	36			105
LG11G	2010	2171	2412	80 1/2	36			110

Veneer species must be noted on each line item

Veneer species must be noted on each line item

Veneer Grade 1	Veneer Grade 2	Veneer Grade 3
Cherry	Rift Oak	Anigre
Maple	Sapele	
Ligno-Grain		
Walnut		

HBF LOGICwork

Freestanding Desks

Style Number	Description	List Price			Dimensions			
		Veneer 1	Veneer 2	Veneer 3	OW	OD	OH	Weight
Half Arched Boat Desk Top, Edge Profile 3 Sides								
LG16A		3185	3440	3822	77 1/2	34		90
LG16C		3265	3526	3918	83 1/2	34		100
LG16D		3215	3472	3858	77 1/2	40		110
LG16F		3295	3559	3954	83 1/2	40		125

Veneer species must be noted on each line item

Desk Pedestals, Wood with Wood Drawer Fronts

LG02A	Box/Box/File	1585	1712	1902	18	22 3/4	25 1/2	135
LG02B	File/File	1585	1712	1902	18	22 3/4	25 1/2	135

Veneer species must be noted on each line item

Veneer species must be noted on each line item

End Panels for Single Pedestal Desks

					OW			
LG[P or B] 02K with Veneer Panel		670	724	804	N/A			48

[P or B]: indicate P for Satin Pewter, B for Satin Bronze

Veneer species must be noted on each line item

LG[P or B] 02L		465	N/A	N/A	N/A			25
----------------	--	-----	-----	-----	-----	--	--	----

[P or B]: indicate P for Satin Pewter, B for Satin Bronze

Modesty Panels

					OW			
LG02H1	Used with double pedestal desks	405	437	486	Varies			32
LG02H2	Used with single pedestal desks	585	632	702	Varies			41

Veneer species must be noted on each line item

Note: A recessed end panel is used when the side of the single pedestal desk is placed against a wall

Veneer species must be noted on each line item

Veneer Grade 1	Veneer Grade 2	Veneer Grade 3
Cherry	Rift Oak	Anigre
Maple	Sapele	
Ligno-Grain		
Walnut		

HBF LOGICwork

Table Desks

Style Number	List Price			Dimensions				
	Veneer 1	Veneer 2	Veneer 3	OW	OD	OH	Weight	
Rectangular with Panel Bases								
	LG01A-T [P or B]	3465	3742	4158	66	30	29	220
	LG01C-T [P or B]	3545	3829	4254	66	36	29	230
	LG01D-T [P or B]	3495	3775	4194	72	30	29	235
	LG01F-T [P or B]	3575	3861	4290	72	36	29	245

Veneer species must be noted on each line item

[P or B]: indicate P for Satin Pewter, B for Satin Bronze

Center drawer standard

Crescent with Panel Bases

	LG04A-T [P or B]	5265	5686	6318	84	36	29	240
	LG04C-T [P or B]	5345	5773	6414	88	42	29	250
	LG04D-T [P or B]	5295	5719	6354	91	37	29	255
	LG04F-T [P or B]	5375	5805	6450	96	43	29	265

Veneer species must be noted on each line item

[P or B]: indicate P for Satin Pewter, B for Satin Bronze

Center drawer standard

Arched Boat with Panel Bases

	LG06A-T [P or B]	5565	6010	6678	84	34	29	240
	LG06C-T [P or B]	5645	6097	6774	90	34	29	250
	LG06D-T [P or B]	5595	6043	6714	84	40	29	255
	LG06F-T [P or B]	5675	6129	6810	90	40	29	265

Veneer species must be noted on each line item

[P or B]: indicate P for Satin Pewter, B for Satin Bronze

Center drawer standard

Rectangular with Panel Bases, Modesty Panel

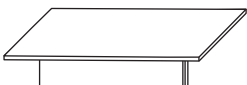
	LG01A-T [P or B]M	3965	4282	4758	66	30	29	220
	LG01C-T [P or B]M	4045	4369	4854	66	36	29	230
	LG01D-T [P or B]M	3995	4315	4794	72	30	29	235
	LG01F-T [P or B]M	4075	4401	4890	72	36	29	245

Veneer species must be noted on each line item

[P or B]: indicate P for Satin Pewter, B for Satin Bronze

Center drawer standard

Veneer species must be noted on each line item

Veneer Grade 1	Veneer Grade 2	Veneer Grade 3
Cherry	Rift Oak	Anigre
Maple	Sapele	
Ligno-Grain		
Walnut		

HBF LOGICwork

Table Desks

Style Number	List Price			Dimensions			
	Veneer 1	Veneer 2	Veneer 3	OW	OD	OH	Weight
Crescent with Panel Bases, Modesty Panel							
<u>LG04A-T [P or B]M</u>	5765	6226	6918	84	36	29	240
<u>LG04C-T [P or B]M</u>	5845	6313	7014	88	42	29	250
<u>LG04D-T [P or B]M</u>	5795	6259	6954	91	37	29	255
<u>LG04F-T [P or B]M</u>	5875	6345	7050	96	43	29	265

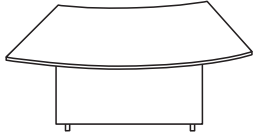

Veneer species must be noted on each line item

[P or B]: indicate P for Satin Pewter, B for Satin Bronze

Center drawer standard

Arched Boat with Panel Bases, Modesty Panel

<u>LG06A-T [P or B]M</u>	6065	6550	7278	84	34	29	240
<u>LG06C-T [P or B]M</u>	6145	6637	7374	90	34	29	250
<u>LG06D-T [P or B]M</u>	6095	6583	7314	84	40	29	255
<u>LG06F-T [P or B]M</u>	6175	6669	7410	90	40	29	265

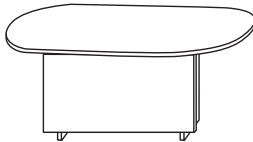

Veneer species must be noted on each line item

[P or B]: indicate P for Satin Pewter, B for Satin Bronze

Center drawer standard

Veneer species must be noted on each line item

Veneer Grade 1 Veneer Grade 2 Veneer Grade 3

Cherry

Rift Oak

Anigre

Maple

Sapele

Ligno-Grain

Walnut

HBF LOGICwork

Freestanding Credenzas

- LOGICwork freestanding credenzas are specified by components; tops, storage components, end panels and removable access panels
- Credenza tops are available with edge details on 1,2 3 or 4 sides
- Credenza tops specified with edge details on all 4 sides will also include a fixed, finished modesty panel
- OW shown is nominal width, Add 2-1/2" for each end that has edge detail
- The backs of storage components specified for use with a credenza tops with edge details on 1,2 or 3 sides will be black
- OD shown is nominal width, actual width with edge detail is 24-7/8"

Credenza Tops

Style Numbers: Description

LG 31(w)	Edge detail on the front (user) side. All other edges are flat
LG 32(w)	Edge details on the front side and one end
LG 33(w)	Edge details on the front side and both ends
LG 33(w)L	Edge details on front, back and left edge, includes a fixed, finished modesty panel
LG 33(w)R	Edge details on front, back and right edge, includes a fixed, finished modesty panel
LG 34(w)	Edge details on all four sides, includes a fixed, finished modesty panel

Width Codes (w):	Nominal Width	List Price Style Numbers 31, 32, 33			List Price Style Numbers 33(w)L, 33(w)R, 34			Weight
		Veneer 1	Veneer 2	Veneer 3	Veneer 1	Veneer 2	Veneer 3	
M	18	395	427	474	1015	1096	1218	33
N	24	435	470	522	1065	1150	1278	37
P	30	545	589	654	1165	1258	1398	41
R	36	585	632	702	1215	1312	1458	45
S	42	645	697	774	1265	1366	1518	49
A	48	685	740	822	1315	1420	1578	53
B	54	955	1031	1146	1625	1755	1950	57
C	60	995	1075	1194	1665	1798	1998	61
D	66	1045	1129	1254	1775	1917	2130	65
E	72	1095	1183	1314	1805	1949	2166	70
F	78	1245	1345	1494	2155	2327	2586	75
G	84	1295	1399	1554	2205	2381	2646	80
H	90	1345	1453	1614	2365	2554	2838	85
J	96	1395	1507	1674	2415	2608	2898	90
K	102	1445	1561	1734	2645	2857	3174	96
L	108	1465	1582	1758	2685	2900	3222	102
T	114	1565	1690	1878	2835	3062	3402	108
U	120 (2 piece top)	1585	1712	1902	2865	3094	3438	116
V	126 (2 piece top)	2335	2522	2802	3615	3904	4338	126
W	132 (2 piece top)	2385	2576	2862	3665	3958	4398	136
X	138 (2 piece top)	2435	2630	2922	3715	4012	4458	146



Edge Detail - 1 Edge (**31**)
Nominal Width = Actual Width
Actual Depth = 25"
Standard Black Unfinished Back



Edge Detail - 2 Edges (**32**)
Nominal Width + 2 1/2" = Actual Width
Actual Depth = 25"
Standard Black Unfinished Back



Edge Detail - 3 Edges (**33**)
Nominal Width + 5" = Actual Width
Actual Depth = 25"
Standard Black Unfinished Back



Edge Detail - 3 Edges **33(w)L**
Nominal Width + 2 1/2" = Actual Width
Actual Depth = 25"
Finished Back



Edge Detail - 3 Edges **33(w)R**
Nominal Width + 2 1/2" = Actual Width
Actual Depth = 25"
Finished Back



Edge Detail - 4 Edges (**34**)
Nominal Width + 5" = Actual Width
Actual Depth = 25"
Finished Back

HBF LOGICwork

Freestanding Credenzas, Removable Access Panels, End Panels

Style Number	Description	List Price			Dimensions			
		Veneer 1	Veneer 2	Veneer 3	OW	OD	OH	Weight
Credenza Pedestals, Wood Cases with Wood Drawer Fronts								
LG 30A	Box/Box/File	1485	1604	1782	18	20	25 1/2	125
LG 30B	File/File	1485	1604	1782	18	20	25 1/2	125
LG 30C	Lateral File	1790	1933	2148	30	20	25 1/2	140
LG 30D	Lateral File	1895	2047	2274	36	20	25 1/2	140
LG 30UL	Single Door Cabinet	1210	1307	1452	18	20	25 1/2	95
LG 30UR	Single Door Cabinet	1210	1307	1452	18	20	25 1/2	95
LG 30E	Double Door Cabinet	1515	1636	1818	30	20	25 1/2	105
LG 30F	Double Door Cabinet	1545	1669	1854	36	20	25 1/2	110

Veneer species must be noted on each line item

[P or B]: indicate P for Satin Pewter, B for Satin Bronze, cases only

Removable Access Panel with Wood Face

LG30G1	365	394	438	6"-30"	24
LG30G2	425	459	510	31"-60"	42
LG30G3	785	848	942	61"-90"	60
LG30G4	1065	1150	1278	91"-138"	

Veneer species must be noted on each line item

Removable Access Panel with Melamine Face

LG[P or B]30G1	265	N/A	N/A	6"-30"	24
LG[P or B]30G2	325	N/A	N/A	31"-60"	42
LG[P or B]30G3	685	N/A	N/A	61"-90"	60
LG[P or B]30G4	965	N/A	N/A	91"-138"	60

[P or B]: indicate P for Satin Pewter, B for Satin Bronze

End Panels with Veneer Panel

LG[P or B]30K	670	724	804	N/A	45
---------------	-----	-----	-----	-----	----

[P or B]: indicate P for Satin Pewter, B for Satin Bronze

Veneer species must be noted on each line item

LG[P or B]30L	465	N/A	N/A	N/A	22
---------------	-----	-----	-----	-----	----

[P or B]: indicate P for Satin Pewter, B for Satin Bronze

Veneer species must be noted on each line item

Veneer Grade 1	Veneer Grade 2	Veneer Grade 3
Cherry	Rift Oak	Anigre
Maple	Sapele	
Ligno-Grain		
Walnut		

HBF LOGICwork

Reception Desks

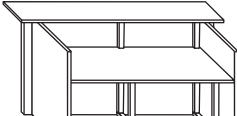
Style Number	List Price			Worksurface Length	Dimensions			Weight	
	Veneer 1	Veneer 2	Veneer 3		OW	OD	OH		
	LG81E[P or B]W-KHK	5695	6151	6834	69 3/4	81 3/4	35 3/4	42	265
	LG81F[P or B]W-KHK	5995	6475	7194	75 3/4	87 3/4	35 3/4	42	280
	LG81G[P or B]W-KHK	6595	7123	7914	81 3/4	93 3/4	35 3/4	42	295
	LG81H[P or B]W-KHK	6895	7447	8274	87 3/4	99 3/4	35 3/4	42	310

Veneer species must be noted on each line item

[P or B]: indicate P for Satin Pewter, B for Satin Bronze

Note: W indicates wood transaction shelf.

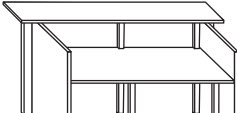
	LG81E[P or B]A-KHK	6895	7447	8274	69 3/4	81 3/4	35 3/4	42	295
	LG81F[P or B]A-KHK	7195	7771	8634	75 3/4	87 3/4	35 3/4	42	310
	LG81G[P or B]A-KHK	7795	8419	9354	81 3/4	93 3/4	35 3/4	42	325
	LG81H[P or B]A-KHK	8095	8743	9714	87 3/4	99 3/4	35 3/4	42	335

Veneer species must be noted on each line item

[P or B]: indicate P for Satin Pewter, B for Satin Bronze

Note: A indicates acrylic solid surface transaction shelf. Specify Alabaster White or Ebony Skies on order.

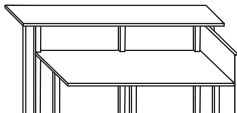
	LG81E[P or B]W-LHK/KHL	5095	5503	6114	69 3/4	81 3/4	35 3/4	42	245
	LG81F[P or B]W-LHK/KHL	5395	5827	6474	75 3/4	87 3/4	35 3/4	42	260
	LG81G[P or B]W-LHK/KHL	5995	6475	7194	81 3/4	93 3/4	35 3/4	42	275
	LG81H[P or B]W-LHK/KHL	6295	6799	7554	87 3/4	99 3/4	35 3/4	42	290

Veneer species must be noted on each line item

[P or B]: indicate P for Satin Pewter, B for Satin Bronze

Note: W indicates wood transaction shelf. LHK indicates finished right-hand. KHL indicates finished left-hand.

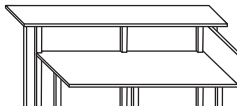
	LG81E[P or B]A-LHK/KHL	6295	6799	7554	69 3/4	81 3/4	35 3/4	42	275
	LG81F[P or B]A-LHK/KHL	6595	7123	7914	75 3/4	87 3/4	35 3/4	42	290
	LG81G[P or B]A-LHK/KHL	7195	7771	8634	81 3/4	93 3/4	35 3/4	42	305
	LG81H[P or B]A-LHK/KHL	7495	8095	8994	87 3/4	99 3/4	35 3/4	42	315

Veneer species must be noted on each line item

[P or B]: indicate P for Satin Pewter, B for Satin Bronze

Note: A indicates acrylic solid surface transaction shelf. Specify Alabaster White or Ebony Skies on order.

LHK indicates finished right-hand. KHL indicates finished left-hand.

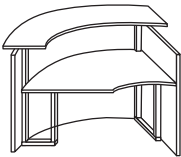
	LG82[P or B]W-LHK/KHL	4245	4585	5094		54 3/8	64 1/4	42	195
	LG82[P or B]A-LHK/KHL	5845	6313	7014		54 3/8	64 1/4	42	225

Veneer species must be noted on each line item

[P or B]: indicate P for Satin Pewter, B for Satin Bronze

Note: W indicates wood transaction shelf.

A indicates acrylic solid surface transaction shelf. Specify Alabaster White or Ebony Skies on order.

LHK indicates finished right-hand. KHL indicates finished left-hand.

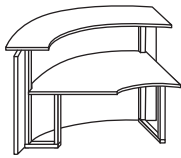
	LG82[P or B]W-LHL	3495	3775	4194		54 3/8	64 1/4	42	175
	LG82[P or B]A-LHL	5095	5503	6114		54 3/8	64 1/4	42	205

Veneer species must be noted on each line item

[P or B]: indicate P for Satin Pewter, B for Satin Bronze

Note: W indicates wood transaction shelf.

A indicates acrylic solid surface transaction shelf. Specify Alabaster White or Ebony Skies on order.

Veneer species must be noted on each line item

Veneer Grade 1 Veneer Grade 2 Veneer Grade 3

Cherry Rift Oak Anigre
Maple Sapele
Ligno-Grain
Walnut

HBF LOGICwork

Reception Desks, Returns

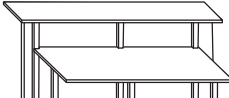
Style Number	List Price			Worksurface Length	Dimensions			Weight	
	Veneer 1	Veneer 2	Veneer 3		OW	OD	OH		
	LG81E[P or B]W-LHL	4895	5287	5874	69 3/4	81 3/4	35 3/4	42	230
	LG81F[P or B]W-LHL	5195	5611	6234	75 3/4	87 3/4	35 3/4	42	245
	LG81G[P or B]W-LHL	5795	6259	6954	81 3/4	93 3/4	35 3/4	42	260
	LG81H[P or B]W-LHL	6095	6583	7314	87 3/4	99 3/4	35 3/4	42	275

Veneer species must be noted on each line item
 [P or B]: indicate P for Satin Pewter, B for Satin Bronze
 Note: W indicates wood transaction shelf.

	LG81E[P or B]A-LHL	6095	6583	7314	69 3/4	81 3/4	35 3/4	42	260
	LG81F[P or B]A-LHL	6395	6907	7674	75 3/4	87 3/4	35 3/4	42	275
	LG81G[P or B]A-LHL	6995	7555	8394	81 3/4	93 3/4	35 3/4	42	295
	LG81H[P or B]A-LHL	7295	7879	8754	87 3/4	99 3/4	35 3/4	42	305

Veneer species must be noted on each line item
 [P or B]: indicate P for Satin Pewter, B for Satin Bronze
 Note: A indicates acrylic solid surface transaction shelf. Specify Alabaster White or Ebony Skies on order.

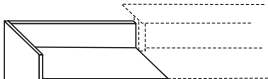
	LG85R-HK/KH	1795	1939	2154		37 1/8	30	35	105
	LG85S-HK/KH	2095	2263	2514		43 1/8	30	35	125
	LG85A-HK/KH	2395	2587	2874		49 1/8	30	35	145

Veneer species must be noted on each line item
 Note: HK indicates right-hand, KH indicates left-hand.

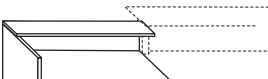
	LG86R-HK/KH	2095	2263	2514		37 1/8	30	36	125
	LG86S-HK/KH	2395	2587	2874		43 1/8	30	36	145
	LG86A-HK/KH	2695	2911	3234		49 1/8	30	36	165

Veneer species must be noted on each line item
 Note: HK indicates right-hand, KH indicates left-hand.

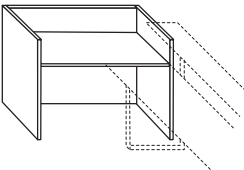
	LG83P-KHK	2195	2371	2634		32 1/4	24	35	135
	LG83R-KHK	2245	2425	2694		38 1/4	24	35	155
	LG83S-KHK	2295	2479	2754		44 1/4	24	35	175
	LG83A-KHK	2345	2533	2814		50 1/4	24	35	195
	LG83B-KHK	2395	2587	2874		56 1/4	24	35	215
	LG83C-KHK	2445	2641	2934		62 1/4	24	35	235
	LG83D-KHK	2495	2695	2994		68 1/4	24	35	255
	LG83E-KHK	2545	2749	3054		74 1/4	24	35	275
	LG83F-KHK	2595	2803	3114		80 1/4	24	35	295
	LG83G-KHK	2645	2857	3174		86 1/4	24	35	315
	LG83H-KHK	2695	2911	3234		92 1/4	24	35	335
	LG83J-KHK	2745	2965	3294		98 1/4	24	35	355
	LG83K-KHK	2795	3019	3354		104 1/4	24	35	375

Veneer species must be noted on each line item

Veneer species must be noted on each line item

Veneer Grade 1	Veneer Grade 2	Veneer Grade 3
Cherry	Rift Oak	Anigre
Maple	Sapele	
Ligno-Grain		
Walnut		

HBF LOGICwork

Reception Desks, Returns

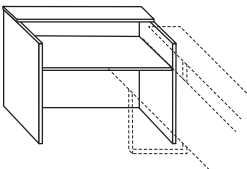
Style Number	List Price			Worksurface Length	Dimensions			Weight
	Veneer 1	Veneer 2	Veneer 3		OW	OD	OH	
	LG84P-KHK	2495	2695	2994	32 1/4	24	36	155
	LG84R-KHK	2545	2749	3054	38 1/4	24	36	175
	LG84S-KHK	2595	2803	3114	44 1/4	24	36	195
	LG84A-KHK	2645	2857	3174	50 1/4	24	36	215
	LG84B-KHK	2695	2911	3234	56 1/4	24	36	235
	LG84C-KHK	2745	2965	3294	62 1/4	24	36	255
	LG84D-KHK	2795	3019	3354	68 1/4	24	36	275
	LG84E-KHK	2845	3073	3414	74 1/4	24	36	295
	LG84F-KHK	2895	3127	3474	80 1/4	24	36	315
	LG84G-KHK	2945	3181	3534	86 1/4	24	36	335
	LG84H-KHK	2995	3235	3594	92 1/4	24	36	355
	LG84J-KHK	3045	3289	3654	98 1/4	24	36	375
	LG84K-KHK	3095	3343	3714	104 1/4	24	36	395

Veneer species must be noted on each line item

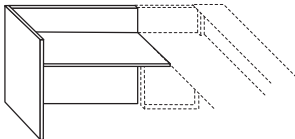
	LG83P-HK/KH	1695	1831	2034	31 1/8	24	35	95
	LG83R-HK/KH	1745	1885	2094	37 1/8	24	35	115
	LG83S-HK/KH	1795	1939	2154	43 1/8	24	35	135
	LG83A-HK/KH	1845	1993	2214	49 1/8	24	35	155
	LG83B-HK/KH	1895	2047	2274	55 1/8	24	35	175
	LG83C-HK/KH	1945	2101	2334	61 1/8	24	35	195
	LG83D-HK/KH	1995	2155	2394	67 1/8	24	35	215
	LG83E-HK/KH	2045	2209	2454	73 1/8	24	35	235
	LG83F-HK/KH	2095	2263	2514	79 1/8	24	35	255
	LG83G-HK/KH	2145	2317	2574	85 1/8	24	35	275
	LG83H-HK/KH	2195	2371	2634	91 1/8	24	35	295
	LG83J-HK/KH	2245	2425	2694	97 1/8	24	35	315
	LG83K-HK/KH	2295	2479	2754	103 1/8	24	35	335

Veneer species must be noted on each line item

Note: HK indicates right-hand, KH indicates left-hand.

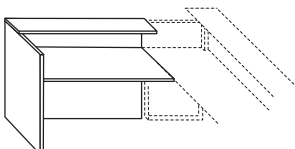
	LG84P-HK/KH	1995	2155	2394	31 1/8	24	36	115
	LG84R-HK/KH	2045	2209	2454	37 1/8	24	36	135
	LG84S-HK/KH	2095	2263	2514	43 1/8	24	36	155
	LG84A-HK/KH	2145	2317	2574	49 1/8	24	36	175
	LG84B-HK/KH	2195	2371	2634	55 1/8	24	36	195
	LG84C-HK/KH	2245	2425	2694	61 1/8	24	36	215
	LG84D-HK/KH	2295	2479	2754	67 1/8	24	36	235
	LG84E-HK/KH	2345	2533	2814	73 1/8	24	36	255
	LG84F-HK/KH	2395	2587	2874	79 1/8	24	36	275
	LG84G-HK/KH	2445	2641	2934	85 1/8	24	36	295
	LG84H-HK/KH	2495	2695	2994	91 1/8	24	36	315
	LG84J-HK/KH	2545	2749	3054	97 1/8	24	36	335
	LG84K-HK/KH	2595	2803	3114	103 1/8	24	36	355

Veneer species must be noted on each line item

Note: HK indicates right-hand, KH indicates left-hand.

Veneer species must be noted on each line item

Veneer Grade 1	Veneer Grade 2	Veneer Grade 3
Cherry	Rift Oak	Anigre
Maple	Sapele	
Ligno-Grain		
Walnut		

HBF LOGICwork Accessories

Style Number	List Price	Dimensions			Weight
		OW	OD	OH	

Garage Mount Monitor Arm

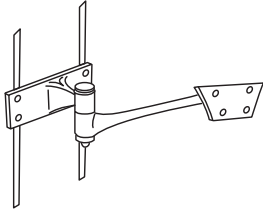

AC[P or B]98F	140			
---------------	-----	--	--	--

[P or B]: indicate P for Satin Pewter, B for Satin Bronze

Note: Monitor arm is supplied with necessary hardware for installation on vertical support of garage. Garage mount monitor arm must be used between two garage vertical supports, and is intended for use only with LOGICwork Garage systems.

Power Center with Grommet

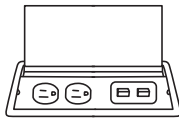

AC[P or B]96M	250	7	10 3/4	
---------------	-----	---	--------	--

[P or B]: indicate P for Satin Pewter, B for Satin Bronze

This power/data unit provides two (2) 110 volt electrical outlets and two data jacks. The unit uses a soft cord with grounded plug.

Curved Accessory Tray Set

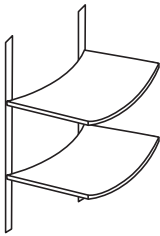

AC[P or B]98H	250	10	10 3/4	
---------------	-----	----	--------	--

Includes mounting hardware for connection to garage vertical and two shelves, intended for use only with the LOGICwork garage system.

AC[P or B]98J	90	10	10 3/4	
---------------	----	----	--------	--

Additional curved shelf for AC [P or B] 98Hs

[P or B]: indicate P for Satin Pewter, B for Satin Bronze

Accessory Trays

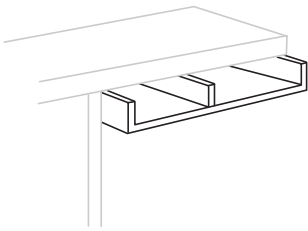

	No. of Compartments		OW	OD	OH	
AC[P or B]96J-18	1	215	18	13 1/2	2 3/4	15
AC[P or B]96J-30	2	235	30	13 1/2	2 3/4	25
AC[P or B]96J-36	3	255	36	13 1/2	2 3/4	30

Includes hardware for attaching to underside of horizontal beam or work surface.

[P or B]: indicate P for Satin Pewter, B for Satin Bronze

Paper Tray

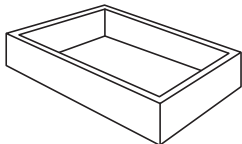

AC[P or B]96K	75	10 1/4	12 1/4	1 3/4	
---------------	----	--------	--------	-------	--

Note: Paper trays may be placed on work surface, pedestal tops, and in LOGICwork accessory trays.

[P or B]: indicate P for Satin Pewter, B for Satin Bronze